catálogo técnico

M E S A S + S I L L A S + T A B U R E T E S

spécifications techniques

T A B L E S + C H A I S E S + T A B O U R E T S

tech specs

T A B L E S + C H A I R S + S T O O L S

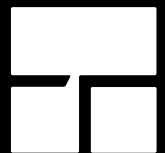

formihogar

índice~sommaire~index

p.04–23 acabados + materiales

finitions + matériaux
finishings + materials

p.24–75 mesas fijas y extensibles

tables fixes et extensibles
fixed and extensible tables

	modelo	tipo	a medida	h	longitud	anchura	patas
p.26	cosmo			75 90	160 180 200	100	
p.30	dekor			75	110 120 130 150	70 80 90	
p.34	class			75	80 90 110 120 130 150	70 80 90	
p.38	open			75	80 90 110 120 130 150	70 80 90	
p.42	poket			75 90	100 110 120	50 65 70 80	
p.46	poket mínima			75	100	50 60	
p.50	class barra			90	80 100 120 140	55	
p.54	lottus recta semioval			75	150 175 210	85 90 100	
p.58	infinity			75 90	consulte p.54	consulte p.54	
p.62	tokio recta / r20 semioval			75 90	70 80 90 110 120	70 80 90	
p.62	tokio redonda			75 90	70 80 90	70 80 90	

cookin heritage

p.68 **fusión** 75 100 | 110 60 | 70

p.70 **menta** 75 100 | 110 | 120 50 | 60 | 65 | 70 | 80

p.74 **alutec** 75 | 90 100 | 110 | 120 50 | 60 | 65 | 70 | 80

p.76–91 **sillas y taburetes**

chaises et tabourets
chairs and stools

	modelo	tipo	estructura	asiento
p.80_s p.88_t	nature	 h80  h65 		
p.80_s p.88_t	loop	 h65 		 
p.81	geniu			 
p.81_s p.89_t	elica	 h80  h65 		 
p.82_s p.89_t	oxford	 h65 		 
p.82_s p.90_t	rental	 h65 		 
p.83	miss			 
p.84	omega			
p.85	nimbus			
p.86	cross			
p.86	bimba			
p.86_s p.88_t	kiss	 h65  h45 		 
p.87	coral			
p.87	core			
p.90	stilo	 h65  h45 		 
p.87_s p.91_t	inés	 h45 		

leyenda

légende
legend



mesa fija

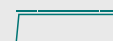

mesa extensible



mesa extensible
cookin heritage



barra pared



opción a medida



aluminio



acero



madera de fresno



silla



taburete h–80



taburete h–65



taburete h–45



tapizado



madera de fresno

medidas indicadas en cm

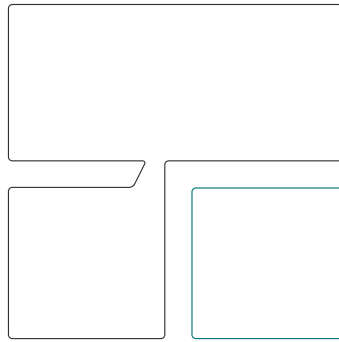

formihogar

A C A B A D O S + M A T E R I A L E S

F I N I T I O N S + M A T É R I A U X

F I N I S H I N G S + M A T E R I A L S



aluminio anodizado



aluminio

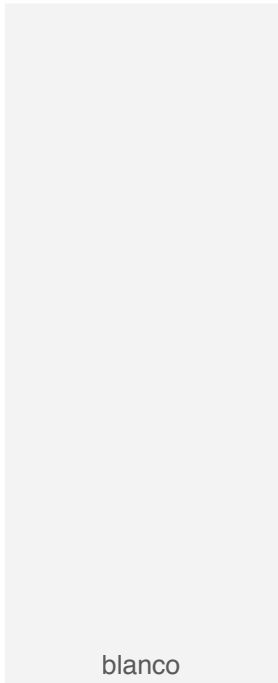

blanco

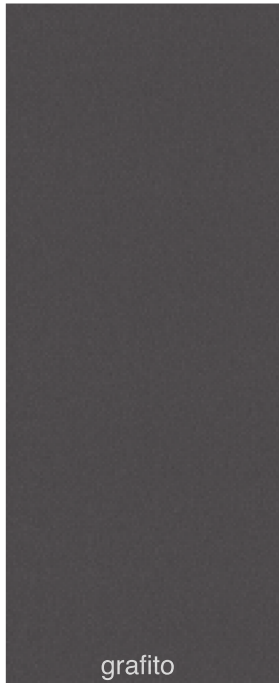

grafito

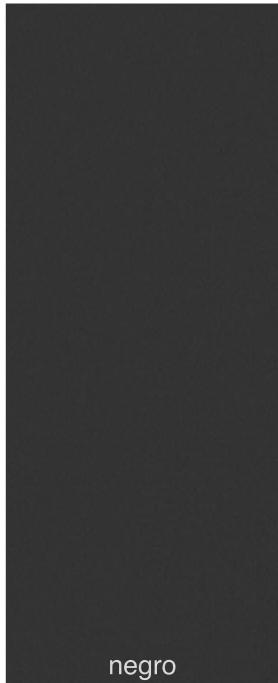

negro

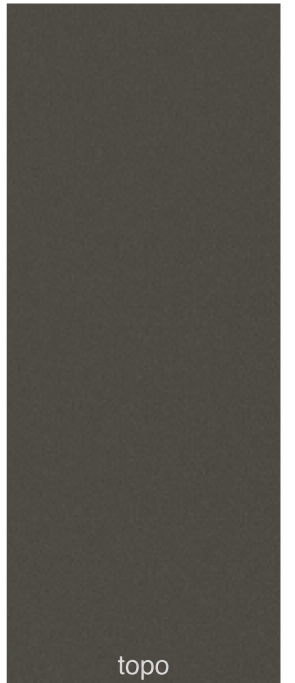

topo



*arizona

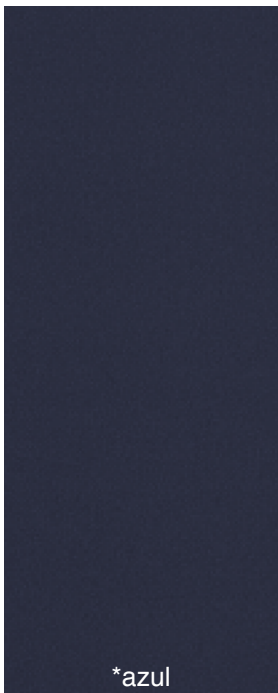

*azul



*verde

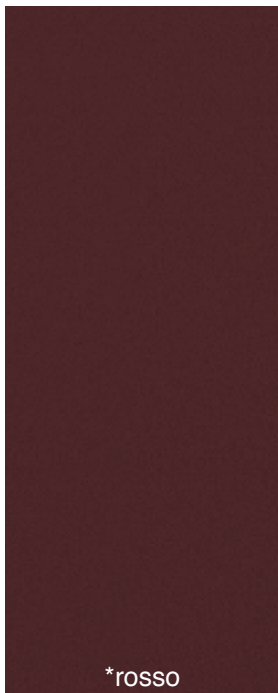

*rosso

aluminio anodizado

aluminio anodizado

es Revestimiento anodizado sobre perfiles de extrusión de aluminio, gran dureza y resistencia.

Disponible para estructuras de mesa infinity y alutec.

aluminium anodisé

fr Revêtement anodisé sur profilés en aluminium extrudé, de grande dureté et de haute résistance.

Disponible sur les structures de table infinity et alutec.

anodised aluminium

en Anodised coating on aluminium extrusion profiles, high hardness and resistance.

Available for infinity and alutec table frames.

acero

acero epoxi

es Revestimiento metálico a base de polvo epoxi para proteger de la oxidación.

Acabado aluminio semimate liso, resto de colores semimate texturado.

Disponible para todas las estructuras de acero en mesas, sillas o taburetes.

acier époxy

fr Revêtement métallique à la résine époxy, pour protéger de l'oxydation. Finition aluminium semi-mat lisse, reste des couleurs, semi-mat texturé.

Disponible sur toutes les structures de tables, de chaises et de tabourets, en acier.

epoxy steel

en Epoxy powder coating to protect from rust. Smooth semi-matt aluminium finish, other semi-matt textured colours.

Available for all steel structures in tables, chairs and stools.

acero *opción color

acero *opción color

es Revestimiento metálico a base de polvo epoxi. Sobre la base de pintura epoxi, se aplica con equipo de alta presión lacado acrílico en diferentes acabados semimate texturado.

**Opcion disponible para todas las estructuras de acero en sillas y taburetes.*

Consultar en catálogo técnico para las estructuras de mesas.

acier *option couleur

fr Revêtement métallique à la résine époxy. À la suite de la peinture époxy, de la laque acrylique est appliquée à l'aide d'un équipement haute pression, dans différentes finitions texturées semi-mates.

**Option disponible sur toutes les structures de chaises et de tabourets, en acier.*

Consulter le catalogue technique des structures de tables.

steel *colour option

en Epoxy powder coating. On epoxy paint base, it is applied with high pressure acrylic lacquered equipment in different textured semi-matte finishes.

**Option available for all steel structures in chairs and stools.*

Consult the technical catalogue for table structures.



fresno nórdico



fresno natural



fresno noche



fresno ártico poro



fresno grafito poro



fresno topo poro



fresno arizona poro

madera fresco barniz o lacado poro

madera de fresno barniz o lacado poro

es Aplicación de tintes y barnices con acabados acrílicos, que garantiza un tono óptimo con el paso del tiempo. La exposición continua a la luz solar, puede variar el color de la madera.

Lacados a poro abierto, que deja entrever la veta y el poro de la madera maciza o chapa de fresno.

Las patas de mesa y estructuras de sillas o taburetes, están realizadas en madera maciza de fresno y contienen vetas y tonos irregulares, matices o nudos de la propia madera, que resaltan aun mas la belleza de la madera y le confiere un aspecto único a cada pieza.

No es posible garantizar en los modelos en madera maciza de fresno, que las vetas o tonos en una misma pieza sean idénticas o regulares.

No se admite la devolución por dichas características en la madera.

Muestrario de fresno barniz o lacado poro.

es Las muestras físicas incluidas en el muestrario de acabados, están fabricadas en chapa de madera de fresno, los colores son similares, pero siempre hay una variación con respecto a la madera maciza de fresno.

bois de frêne verni ou laqué pores

fr Bois de frêne verni ou laqué pores. Application de teintures et de vernis en finitions acryliques, qui garantissent un ton optimal dans le temps. Une exposition continue au soleil peut changer la couleur du bois.

Laquages à pores ouverts, qui n'occulte ni le veinage ni les pores du bois massif ou du placage de frêne.

Les pieds des tables et les structures des chaises ou des tabourets, sont fabriqués en bois de frêne massif, et contiennent des veines et des tons irréguliers, des nuances ou des nœuds du bois lui-même, qui mettent davantage en valeur la beauté du bois, en offrant à chaque pièce un aspect unique.

Sur les modèles en bois de frêne massif, il est impossible de garantir que le veinage ou les tons du bois d'une même pièce soient identiques ou réguliers.

Aucun retour ne sera admis en raison de ces caractéristiques, propres au bois.

Échantillonneur de frêne verni ou laqué pores.

fr Les échantillons physiques contenus dans l'échantillonneur de finitions sont fabriqués en placage de frêne, les couleurs sont similaires, mais il y a toujours une variation par rapport au bois de frêne massif.

ash wood varnished or lacquered pore

en Application of dyes and varnishes with acrylic finishes, which guarantees an optimum tone over time. Continuous exposure to sunlight may change the colour of the wood.

Open-pore lacquering, which reveals the grain and pores of the solid wood or ash veneer.

The table legs and chair or stool frames are made of solid ash wood and contain irregular grains and shades, nuances or knots of the wood itself, which further enhance the beauty of the wood and give each piece a unique appearance.

It cannot be guaranteed that the grains or shades in the same piece of solid ash wood will be identical or regular.

No return is allowed for such characteristics in the wood.

Sample book of varnished or pore lacquered ash.

en The physical samples included in the sample book of finishes are made of ash veneer, the colours are similar, but there is always a variation with respect to solid ash wood.

cristal brillo ✦

es **Cristal óptico brillo**, templado y pintado en colores, el vidrio óptico tiene unas características de tonalidad, que una vez pintado le confiere un blanco o color mas puro. *Consultar disponibilidad de colores según modelo de mesa.*

fr **Verre optique brillant**, trempé et peint de différentes couleurs, le verre optique possède des caractéristiques de tonalités qui, une fois peint, lui confèrent une couleur blanche ou d'une plus grande pureté. *Consultez les disponibilités de couleurs en fonction du modèle de table.*

en **Bright optical glass**, tempered and painted in colours, optical glass has certain shade characteristics, which once painted gives it a white or purer colour. *Consult colour availability according to table model.*



cristal mate antirayas

es **Cristal luxraff mate**,
templado y pintado
en colores.

El vidrio luxraff mate tiene
unas características
especiales antirayas,
apropiado para un uso
intensivo en posición
horizontal.

**Consultar disponibilidad
de colores según modelo
de mesa.**

fr **Verre luxraff mat**,
trempé et peint
de différentes couleurs.

Le verre Luxraff mat
possède des caractéristiques
anti-rayures spéciales,
adaptées à un usage en
position horizontale, intensif.
**Consultez les disponibilités
de couleurs en fonction du
modèle de table.**

en **Luxraff matte glass**
tempered and painted
in colours.

The matte luxraff glass
has special anti-scratch
characteristics, suitable
for intensive use in
horizontal position.
**Consult colour availability
according to table model.**

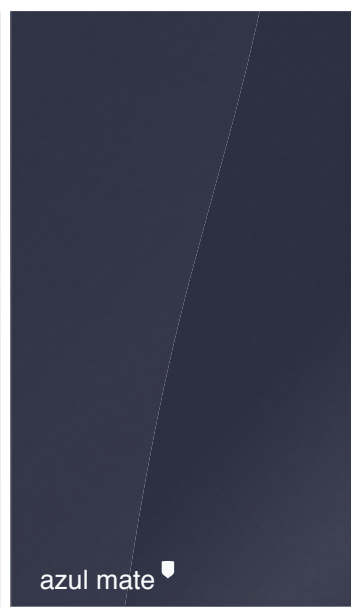
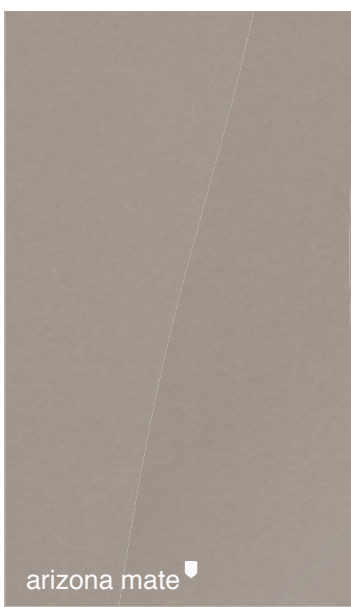
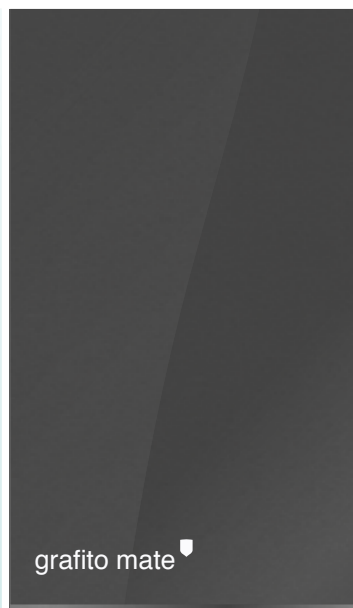

laminado

es **Laminado** en continuo sobre tablero de partículas o mdf, en diferentes colores y texturas.

La superficie de Laminado le confiere excelentes propiedades antibacterianas y una gran resistencia al rayado y uso intensivo.

fr **Stratifié** en continu sur panneaux de particules ou en mdf, de différentes couleurs et textures.

La surface stratifiée leur confère d'excellentes propriétés antibactériennes et une grande résistance face aux rayures et à une utilisation intensive.

en **Laminate** in continuous on particle board or mdf, in different colours and textures.

The laminate surface provides excellent antibacterial properties and high resistance to scratching and intensive use.

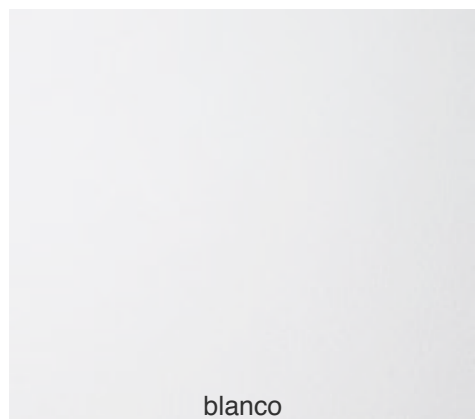

blanco

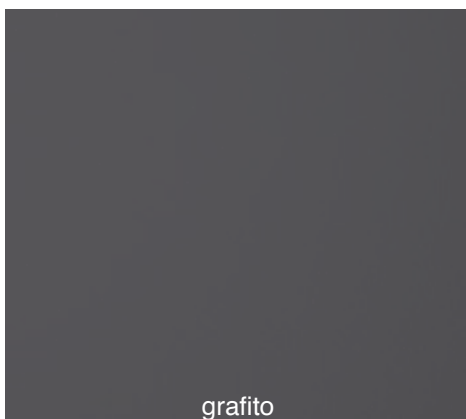

grafito

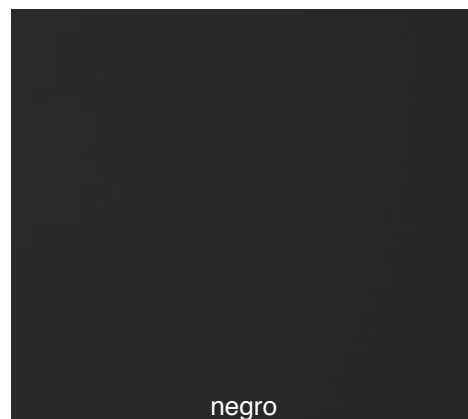

negro

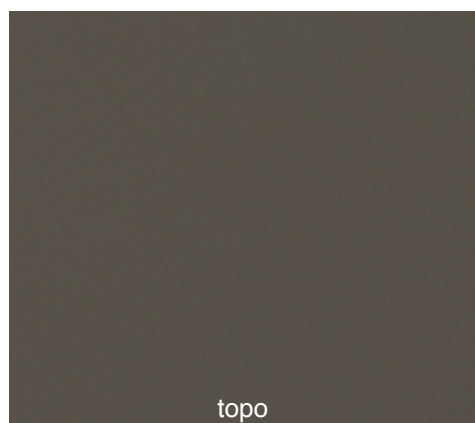

topo

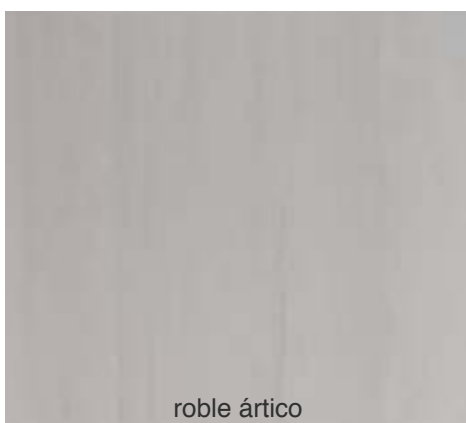

roble ártico

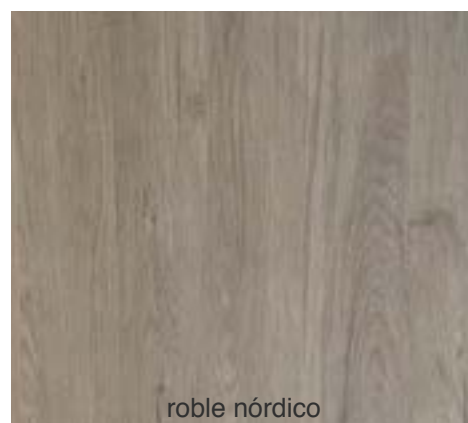

roble nórdico

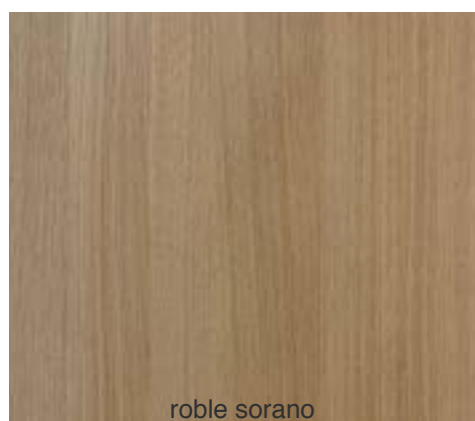

roble sorano

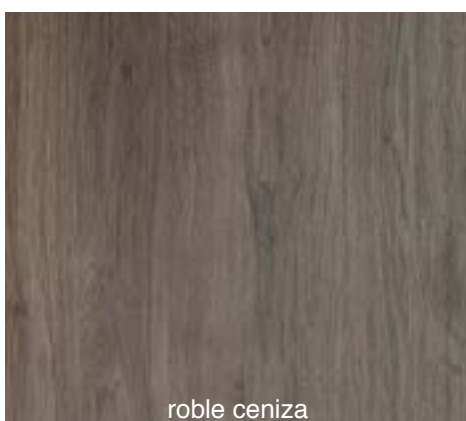

roble ceniza

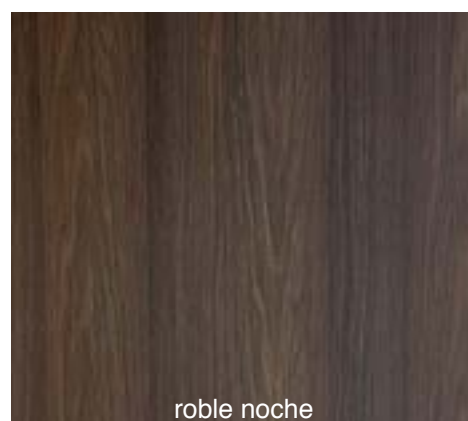

roble noche



roble hera



roble aurora



beton

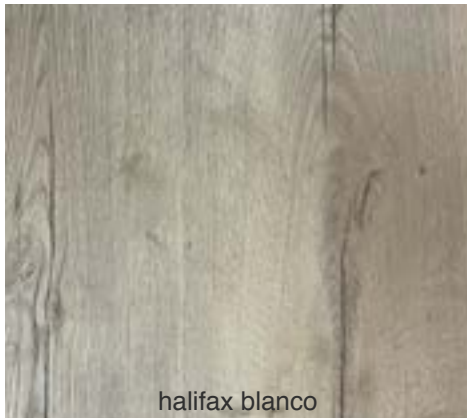

halifax blanco

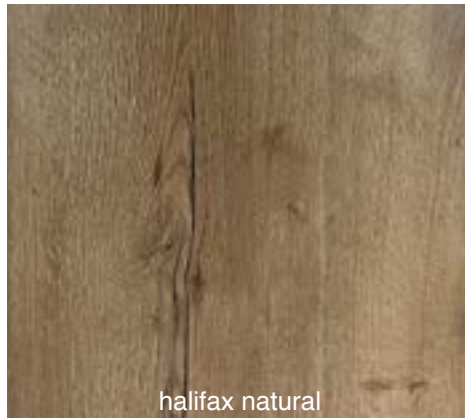

halifax natural

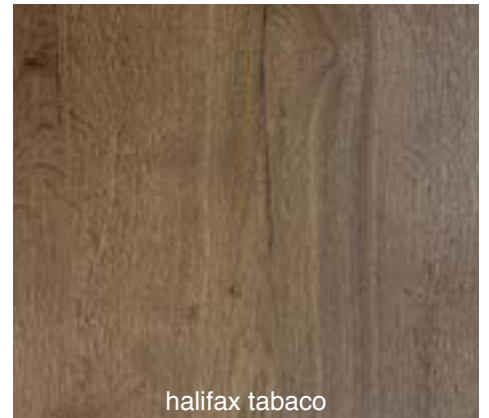

halifax tabaco



polo

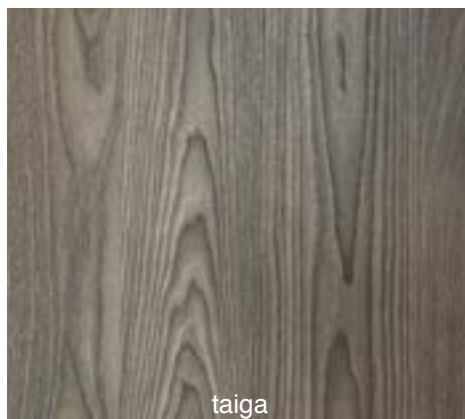

taiga

laminado

Technical Matt Finsa

es **Laminado Technical Matt** es una nueva gama decorativa especialmente diseñada para un uso horizontal intensivo.

Textura ultramate antihuellas de tacto aterciopelado, es apta para contacto con alimentos.

fr **Le stratifié Technical Matt** intègre une nouvelle gamme de décoration spécialement conçue pour un usage horizontal intensif.

Texture ultra-mate anti-empreintes, au toucher velouté, indiquée pour les contacts avec les aliments.

en **Technical Matt Laminate** is a new decorative range specially designed for intensive horizontal use.

Ultramatte texture anti-fingerprint velvety touch, suitable for contact with food.

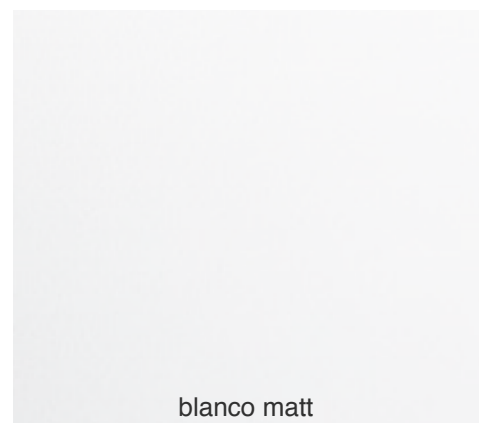

blanco matt



A piedra



B blanco



A carbono

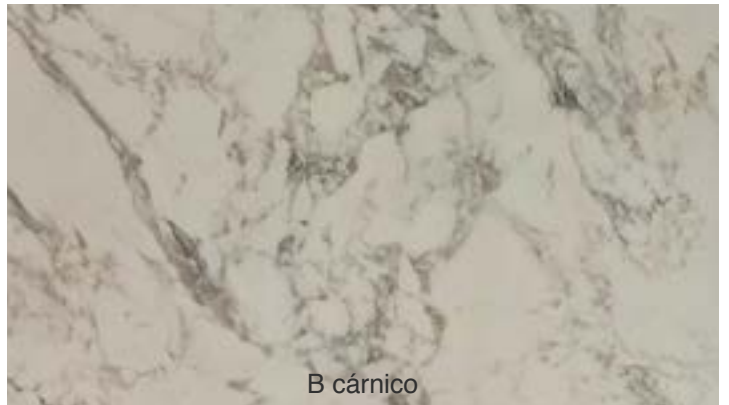

B cárnico



A óxido

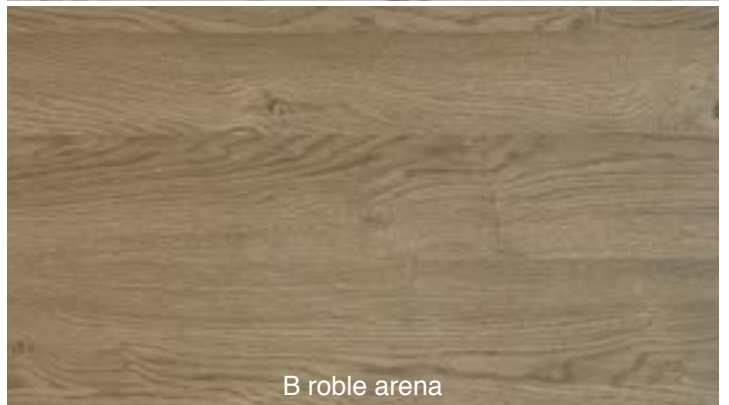

B roble arena

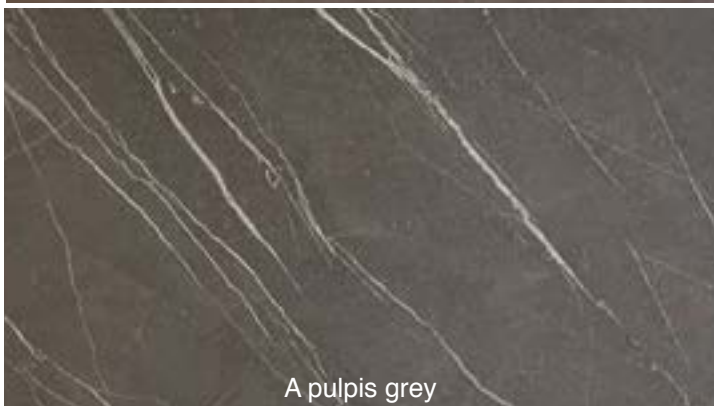

A pulpis grey



B samas



A rapsodia

compacto A/B y FENIX

es **Compacto fenólico** de 3 o 4 mm de grosor, con el **núcleo color marrón kraft en compacto A**, y **núcleo a su color en compacto B y FENIX**.

Los compactos A y B tienen diferentes texturas que le confieren un acabado espectacular e idóneo para encimeras de mesas.

El FENIX, presenta además un acabado aterciopelado y mate antihuellas.

Máxima resistencia a la abrasión, arañazos o golpes, muy por encima de cualquier otro laminado.

Material no poroso con muy baja absorción de manchas y propiedades higiénicas, indicado para el contacto con alimentos.

Sin duda una extraordinaria gama de diseños y acabados para la encimera de tu mesa.

fr **Compact phénolique** de 3 ou 4 mm d'épaisseur, composé d'une âme en compact A de couleur kraft brun, et d'une âme dans sa couleur, en compact B et FENIX.

Les compactes A et B possèdent des textures différentes offrant une finition spectaculaire, idéales pour les plateaux de table.

Le FENIX possède de plus, une finition duvetée et mate anti-empreintes.

Une résistance maximale à l'abrasion, aux rayures ou aux impacts, très supérieure à tout autre stratifié.

Matériau non-poreux à très faible absorption de taches, et doté de propriétés hygiéniques, indiquées pour le contact avec les aliments.

Sans aucun doute, une gamme aux designs et aux finitions extraordinaires, pour le plateau de votre table.

en **Phenolic compact**, 3 or 4 mm thick, with kraft brown core in compact A, and core in its colour in compact B and FENIX.

Compacts A and B have different textures that give them a spectacular finish and are ideal for tabletops.

FENIX also has a velvety and matte anti-fingerprint finish.

Maximum resistance to abrasion, scratches or shocks, far above any other laminate.

Non-porous material with very low stain absorption and hygienic properties, suitable for food contact.

Undoubtedly an extraordinary range of designs and finishes for your tabletop.



arizona FENIX

blue fes FENIX

verde comodoro FENIX

nero ingo FENIX

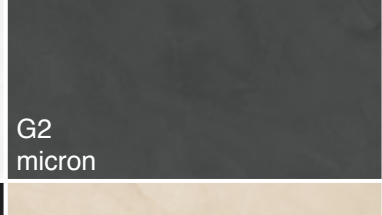
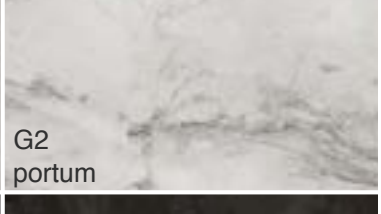
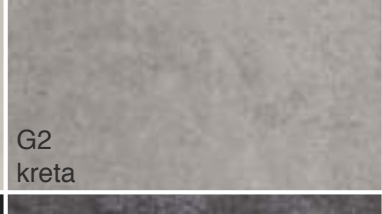
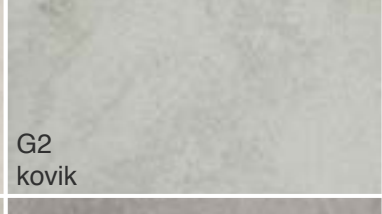
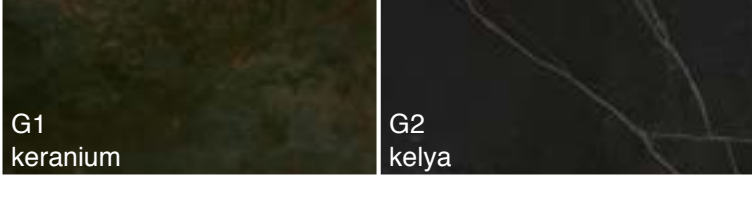
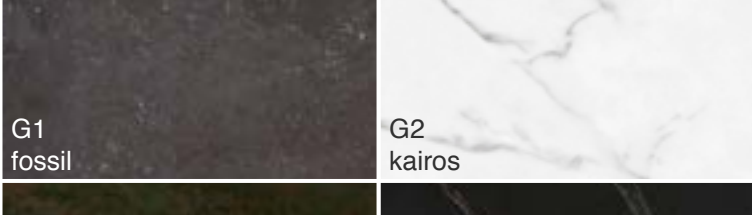
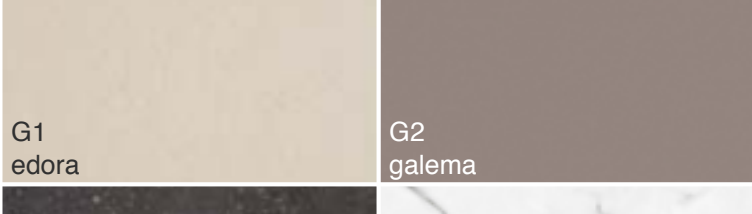
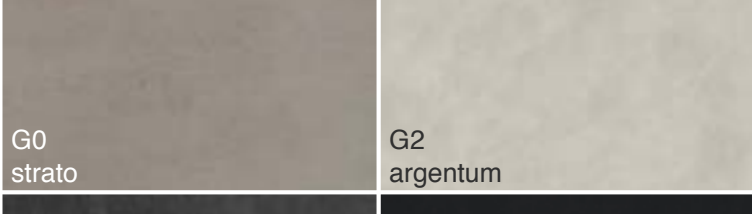
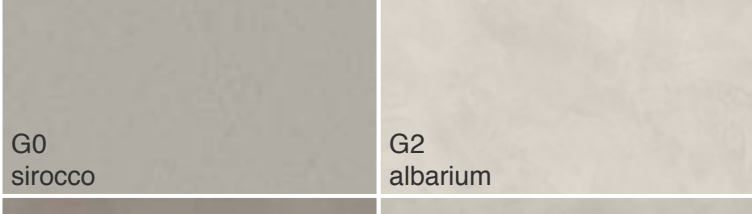
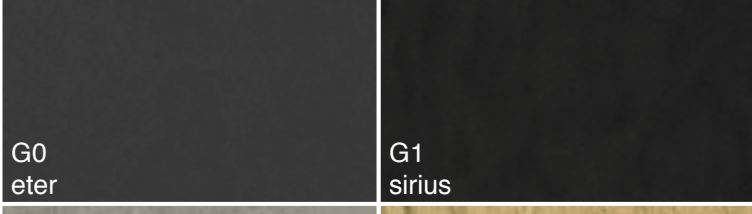

es Información sobre las características de DEKTON.

Consulte en la web www.dekton.es

fr Informations sur les caractéristiques du DEKTON.

Vérifier sur le site www.dekton.es

en Information about DEKTON features.

Consult the website www.dekton.es

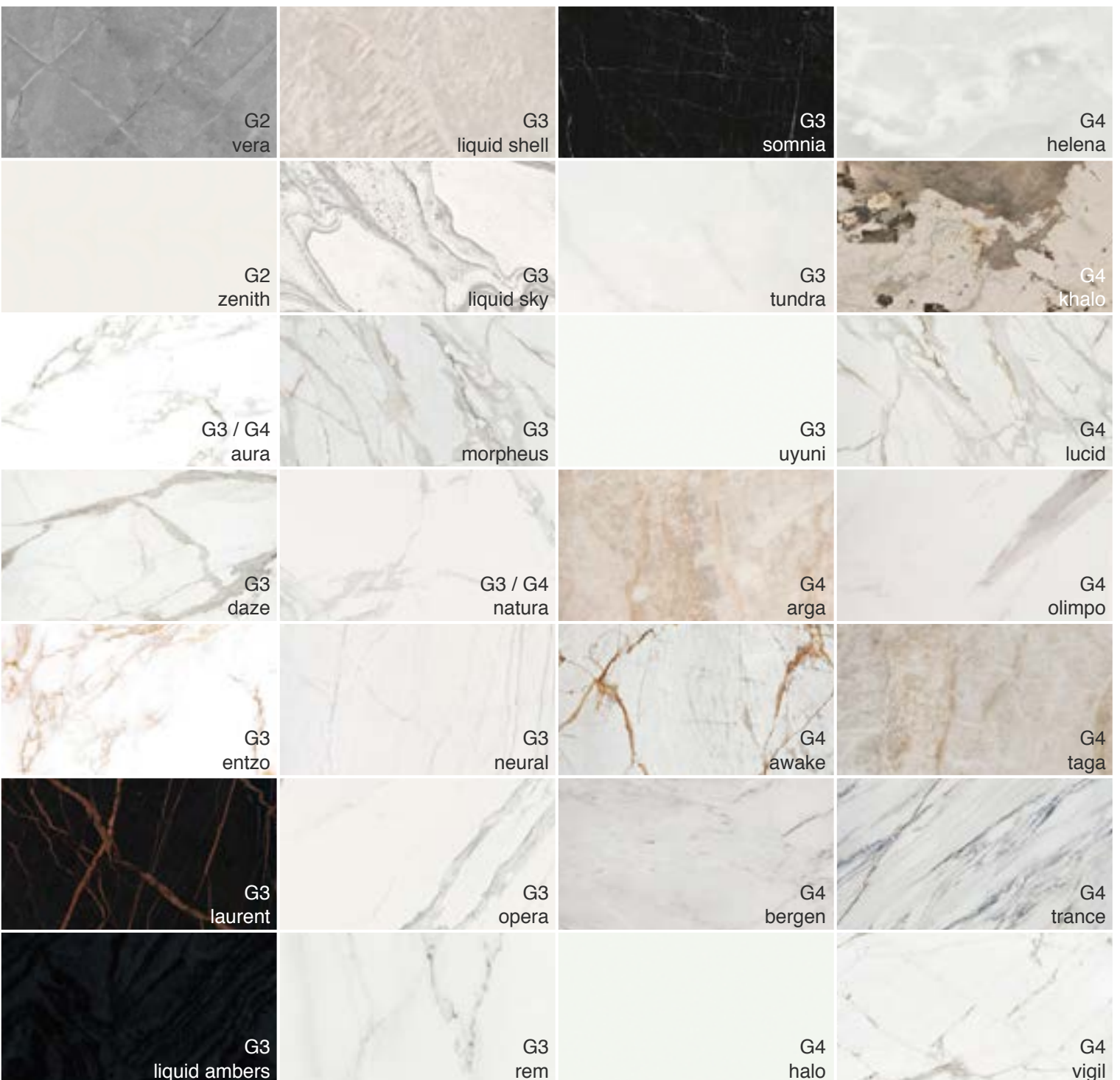

tapizado
vinílico

revêtement
vinyle



vynil
upholstery



tapizado
textil

revêtement
textile

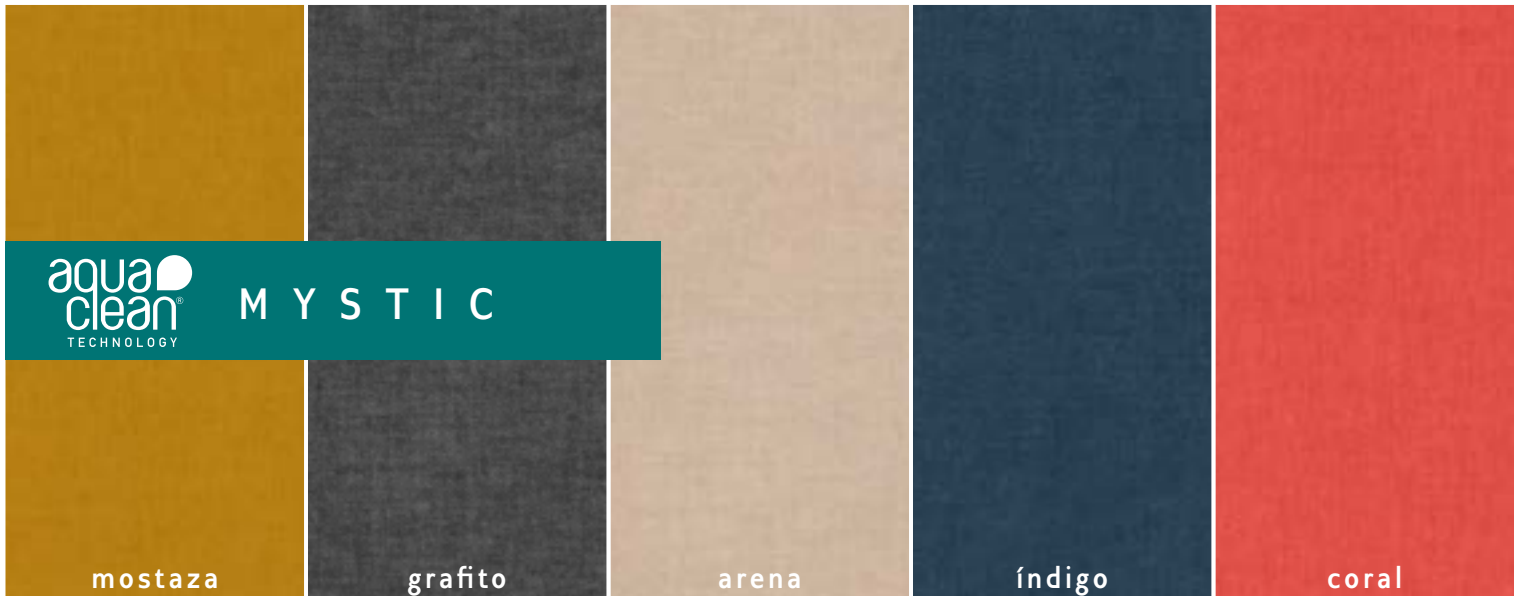

textile
upholstery

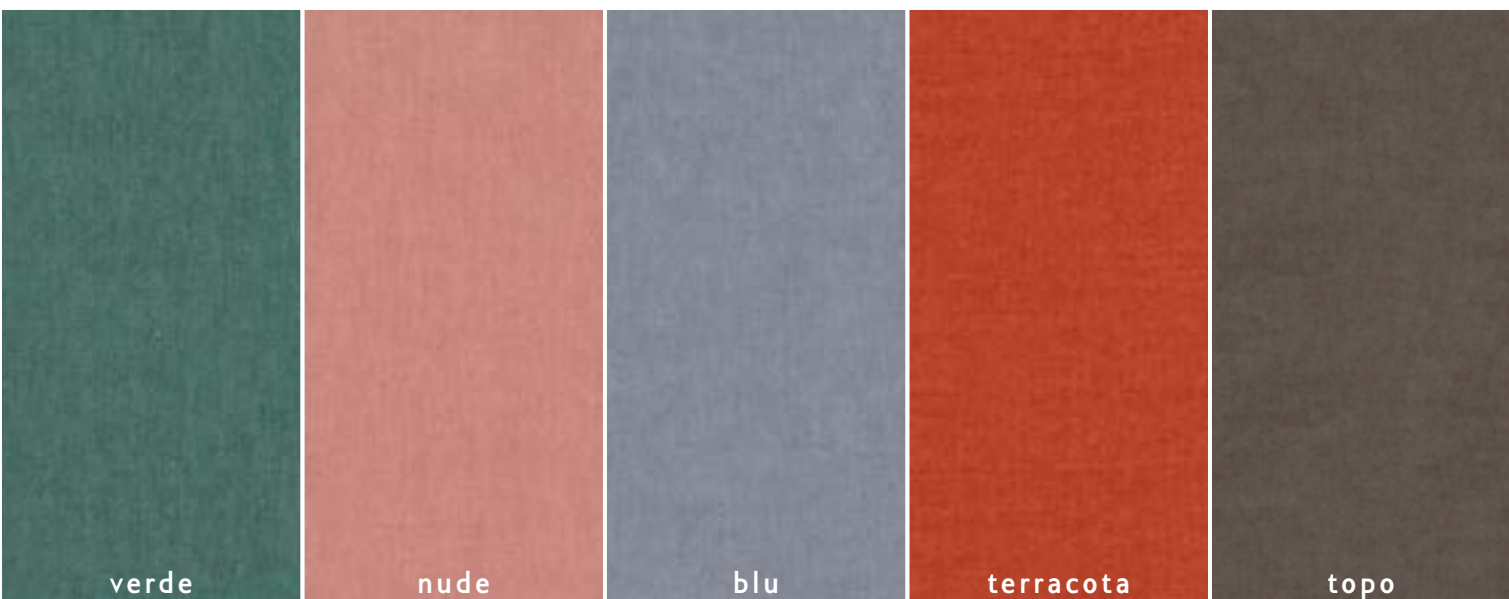

tapizado
vinílico
revêtement
vinyle
vynil
upholstery



V A L E N C I A



L I N E T E X



M A G L I A



S I L V E R T E X

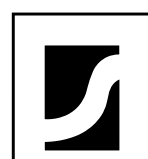

SPRADLING®

composición
100% vinilo

cuidados y limpieza

es Toda mancha, derramamiento o suciedad se debe limpiar con rapidez para evitar un manchado permanente.

Use solamente soluciones jabonosas suaves o productos de limpieza especiales para telas vinílicas para eliminar las manchas de la superficie del material. Limpie solamente con trapos blancos humedecidos.

Ciertas prendas de vestir y tintes de accesorios (como los utilizados en los pantalones vaqueros) pueden migrar a superficies más claras. Este fenómeno se ve incrementado por los efectos de la humedad y la temperatura; es irreversible.

soins et nettoyage

fr Toute tache, déversement ou saleté doit être essuyé le plus rapidement possible pour éviter un marquage permanent.

N'utilisez que des solutions savonneuses douces ou des nettoyeurs spéciaux pour tissus en vinyle, pour enlever les taches sur la surface du matériau. Nettoyez uniquement avec des chiffons blancs humides.

Certains vêtements et certaines teintures pour accessoires (comme celles utilisées sur les jeans) peuvent occasionner des surfaces plus claires. Ce phénomène s'accroît sous les effets de l'humidité et de la température, et il est irréversible.

care and cleaning

en Any stains, spills or soiling should be cleaned up promptly to avoid permanent staining.

Use only mild soap solutions or special cleaning products for vinyl fabrics to remove stains from the surface. Clean only with damp white cloths.

Certain clothing and accessory dyes (such as those used in jeans) may migrate to lighter surfaces. This phenomenon is enhanced by the effects of humidity and temperature; it is irreversible.

tapizado
textil
revêtement
textile
textile
upholstery



M Y S T I C

**aquaclean_limpieza en solo
3 pasos**

es1 Retirar el exceso de residuo vertido en la tapicería.

2 Aplicar agua sobre la mancha, bien de forma directa o bien con un paño absorbente mojado y escurrido.
Esperar unos segundos.

3 Presionar sobre la mancha con el paño y frotar suavemente sobre el tejido con movimientos circulares. Si la mancha no desaparece del todo, volver a repetir el proceso las veces que sea necesario.



**aquaclean_le nettoyage en seulement
3 étapes.**

fr 1 Enlevez l'excédent de résidus renversé sur le tissu.

2 Appliquez de l'eau sur la tache, soit directement, soit avec un chiffon absorbant humide et essoré.
Attendez quelques secondes.

3 Appuyez sur la tache avec le chiffon, et frottez doucement le tissu avec des mouvements circulaires. Si la tache ne disparaît pas complètement, répétez l'opération autant de fois que nécessaire.

**composición
100% poliester**

**aquaclean_cleaning in only
3 steps**

en 1 Remove excess residue spilled on the upholstery.

2 Apply water to the stain, either directly or with an absorbent cloth dampened and wrung out.
Wait a few seconds.

3 Press on the stain with the cloth and rub gently over the fabric with circular movements. If the stain does not disappear completely, repeat the process as many times as required.

f F U J I

**composición
100% PES**

f F R O C A

f f F R O C A

**composición
75% algodón / 25% poliester**

Por su composición, estos tejidos requieren más cuidados con las manchas que otros tejidos de nuestra gama.

En raison de leur composition, ces tissus nécessitent plus de soin contre les taches que les autres tissus de notre gamme.

Due to their composition, these fabrics require more care against stains than other fabrics in our range.

es **cuidados y limpieza**

En caso de manchas, quitar inmediatamente la suciedad con un paño y limpiar suavemente con una solución jabonosa líquida y neutra.

Después limpiar con agua.



Puede lavarse en seco.
It can be dry cleaned.
Il peut être nettoyé à sec.

fr **soins et nettoyage**

Nettoyez immédiatement la saleté avec un morceau de tissu et nettoyez doucement avec une solution de savon liquide et neutre.

Après-nettoyage avec de l'eau propre.



No usar lejía.
Do not use bleach.
Ne pas utiliser eau de javel.

en **care and cleaning**

In case of stains, remove the dirt directly with a tissue and clean tehcn with a neutral soap solution.

After cleaning with pure water.



Evitar secar al Sol.
Avoid drying in the Sun.
Éviter sécher au Soleil.

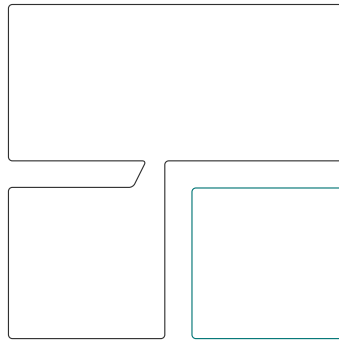

formihogar

M E S A S F I J A S + E X T E N S I B L E S

T A B L E S F I X E S + E X T E N S I B L E S

F I X E D T A B L E S + E X T E N S I B L E S

cosmo

es características técnicas

Mesa fija o extensible.

Encimera: Laminados, compactos A/B y Fenix, Dekton.

Extensión: Igual que la encimera (excepto Dekton, extensión en laminado color similar a patas o Dekton).

Estructura: Perfil de aluminio con guía corredera para su extensión.

Patas: Tipo portería en tubo de acero de 10x6cm. La pata extensible incorpora ruedas para facilitar la apertura. Disponibles en h75 y h90.

fr caractéristiques techniques

Table fixe ou extensible.

Plateau: Stratifiés, compactes A/B et Fenix, Dekton.

Extension: Identique au plateau (sauf Dekton, extension en stratifié de couleur similaire aux pieds ou Dekton).

Structure: Profilé d'aluminium avec glissière d'extension.

Pieds: De type cadre, en tube d'acier de 10x6cm. Le pied extensible intègre des roues pour faciliter l'ouverture. Disponibles en h75 et h90.

en technical specifications

Fixed or extendable table.

Worktop: Laminates, A/B compactes and Fenix, Dekton.

Extension: Same as the worktop (except Dekton, extension in laminate similar colour to legs or Dekton).

Structure: Aluminium profile with sliding guide for extension.

Legs: Goal type in 10x6 cm steel tube. The extendable leg incorporates wheels for easy opening. Available in h75 and h90.



es medidas

FIJA

ONE

fr mesures

en measures

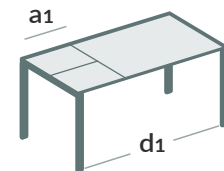

a x b	a1	c	d	d1	h1	h	box
160x100	+60	87	138	198			
180x100	+60	87	158	218	67	75	3
200x100	+80	87	178	258	82*	90*	

*opción h90

acero h75 / opción h90

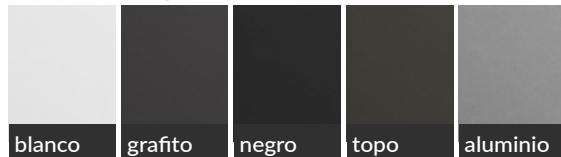

es **ENCIMERA** fr **PLATEAUX** en **WORKTOP**



encimera Laminado 19mm.
canto pvc recto igual a los laminados.
extensión Igual.

laminado | laminado matt

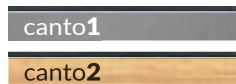

encimera Compacto 4mm + laminado 15mm.
canto1 pvc recto color igual a patas acero.
canto2 pvc recto marino (indicar en pedido).
extensión Igual.



CONTRACHAPADO ABEDUL 15mm

encimera Compacto 4mm + Abedul 15mm.
canto biselado + barniz protector.
extensión Igual.

compacto

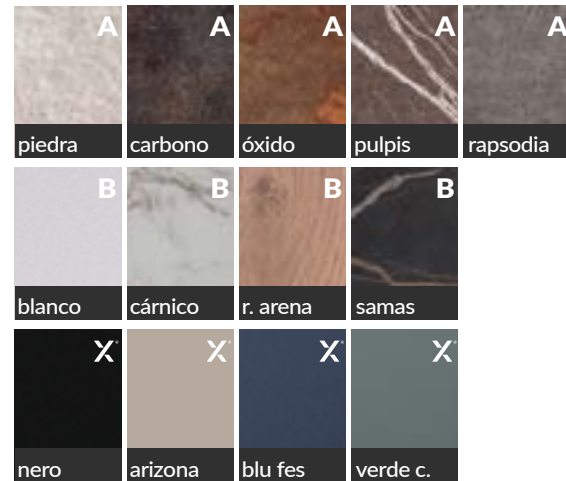

encimera DEKTON 12mm
extensión laminado color similar a DEKTON o patas de acero.



Todos los acabados y grupos. consulte p.16-17

cosmo



FIJA

a x b 160x100 180x100 200x100

LAMINADO	846	892	985
COMPACTO A+LAMINADO	900	962	1069
COMPACTO B+LAMINADO	946	1008	1131
FENIX⁺ LAMINADO	1038	1100	1246
COMPACTO A+ABEDUL 15	1000	1062	1169
COMPACTO B+ABEDUL 15	1046	1108	1231
FENIX⁺ ABEDUL 15	1123	1200	1346

 **DEKTON[®]** Consultar precio con fábrica.
12mm

opción a tu medida

FIJA longitud **a 140** hasta **240** / anchura **b 100**
Consultar precio (excepto cristal). 

es **opción** mesa Cosmo fr **option** table Cosmo en **option** table Cosmo

+54 Patas h90.
Medida mesa máximo 200x100cm.



ONE

a x b	160x100	180x100	200x100
a1	60	60	80
LAMINADO	1062	1108	1200
COMPACTO A +LAMINADO	1131	1192	1300
COMPACTO B +LAMINADO	1192	1254	1377
FENIX + LAMINADO	1300	1377	1523
COMPACTO A +ABEDUL	1246	1308	1415
COMPACTO B +ABEDUL	1308	1369	1492
FENIX +ABEDUL	1415	1492	1638

dekor

es características técnicas

Mesa fija o extensible.

Encimera: Laminados. Compactos A/B y Fenix, sobre madera contrachapada de abedul de 15mm de grosor, borde biselado.

Extensión: Igual que la encimera.

Estructura Perfil de aluminio con guía corredera para su extensión.

Patas: Tipo portería en tubo de acero de 7x4cm, giradas y ligeramente inclinadas. La pata extensible incorpora ruedas para facilitar la apertura.

fr caractéristiques techniques

Table fixe ou extensible.

Plateau: Stratifiés. Compactos A/B et Fenix, sur contreplaqué de bouleau de 15 mm d'épaisseur, bord biseauté.

Extension: Identique au plateau.

Structure: Profilé d'aluminium avec glissière d'extension.

Pieds: De type cadre en tube d'acier de 7x4cm, retournés et légèrement inclinés. Le pied extensible intègre des roues pour faciliter l'ouverture.

en Technical specifications

Fixed or extendable table.

Worktop: Laminates. A/B compacts and Fenix, on 15mm thick birch plywood, bevelled edge.

Extension: Same as the worktop.

Structure: Aluminium profile with sliding guide for extension.

Legs: Goal type in steel tube of 7x4 cm, rotated and slightly tilted. The extendable leg incorporates wheels for easy opening.



es medidas

FIJA

ONE

fr mesures

en measures



a x b	b1	a1	c	d	d1	h1	h	box
110x70	74	+60	57	97	157	67	75	2
120x70			57	107	167			
120x80	84		67	107	167			
130x80			67	117	177			
130x90	94		77	117	177			
150x90			77	137	197			

acero h75

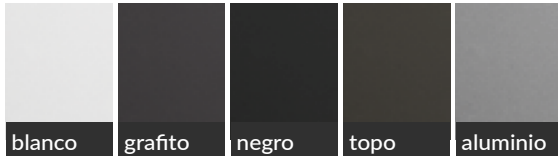

encimera Laminado 19mm.
canto pvc recto igual a los laminados.
extensión Igual.

laminado | laminado matt



CONTRACHAPADO ABEDUL 15mm

encimera Compacto 4mm + Abedul 15mm.
canto biselado + barniz protector.
extensión Igual.

compacto

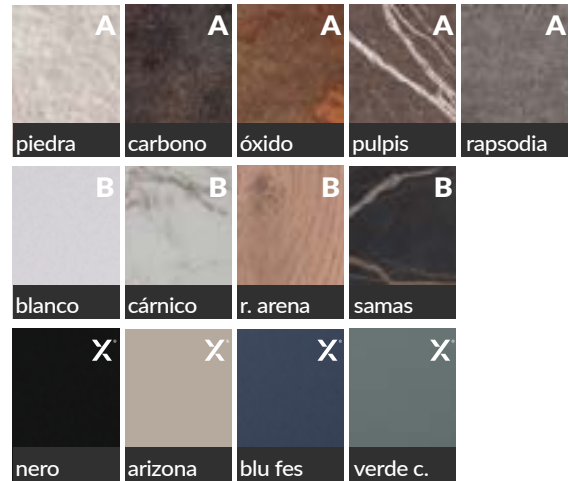



FIJA RECTA

a x b	110x70	120x70	120x80	130x80	130x90	150x90
LAMINADO	494	506	518	552	591	637
LAMINADO MATT	528	540	552	598	637	683

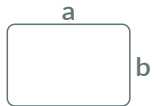

FIJA RECTA r20

a x b	110x70	120x70	120x80	130x80	130x90	150x90
COMPACTO A+ABEDUL 15	591	608	625	680	728	792
COMPACTO B+ABEDUL 15	617	634	651	718	766	831
FENIX+ABEDUL 15	678	695	728	814	866	931

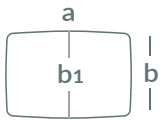

FIJA SEMIOVAL

a x b/b1	110x70/74	120x70/74	120x80/84	130x80/84	130x90/94	150x90/94
COMPACTO A+ABEDUL 15	606	623	640	695	743	808
COMPACTO B+ABEDUL 15	632	649	666	734	782	846
FENIX+ABEDUL 15	694	711	743	829	882	946

opción a tu medida
| | | | | | | |

FIJA longitud a 110 hasta 180 / anchura b 70 – 80 – 90
Consultar precio.





ONE RECTA

a x b	110x70	120x70	120x80	130x80	130x90	150x90
a1	60	60	60	60	60	60
LAMINADO	609	622	634	668	706	752
LAMINADO MATT	643	655	668	714	752	798



ONE RECTA r20

a x b	110x70	120x70	120x80	130x80	130x90	150x90
a1	60	60	60	60	60	60
COMPACTO A+ABEDUL 15	722	738	755	811	858	923
COMPACTO B+ABEDUL 15	755	772	789	857	905	969
FENIX+ABEDUL 15	840	857	889	975	1028	1092

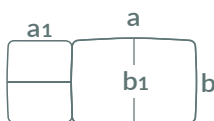

ONE SEMIOVAL

a x b/b1	110x70/74	120x70/74	120x80/84	130x80/84	130x90/94	150x90/94
a1	58	58	58	58	58	58
COMPACTO A+ABEDUL 15	737	754	771	826	874	938
COMPACTO B+ABEDUL 15	771	788	805	872	920	985
FENIX+ABEDUL 15	855	872	905	991	1043	1108

opción a tu medida
| | | | | | | |

ONE longitud **a** 110 hasta 160 / anchura **b** 70 – 80 – 90
Consultar precio.



class

es características técnicas

Mesa fija o extensible.

Encimera: Laminados, cristal, compactos A/B y Fenix, Dekton.

Extensión: Igual que la encimera (excepto en cristal, extensión en laminado blanco; y Dekton, extensión en laminado color similar a patas o Dekton).

Estructura: Perfil de aluminio con guía corredera para su extensión.

Patas: Tipo portería en tubo de acero de 6x3cm.

La pata extensible incorpora ruedas para facilitar la apertura.

fr caractéristiques techniques

Table fixe ou extensible.

Plateau: Stratifiés, verre, compact A/B et Fenix, Dekton.

Extension: Identique au plateau (sauf en verre, extension en stratifié blanc et Dekton, extension en stratifié de couleur similaire aux pieds ou Dekton).

Structure: Profilé d'aluminium avec glissière d'extension.

Pieds: De type cadre, en tube d'acier de 6x3cm.

Le pied extensible intègre des roues pour faciliter l'ouverture.

en Technical specifications

Fixed or extendable table.

Worktop: Laminates, glass, A/B compact and Fenix, Dekton.

Extension: Same as the worktop (except in glass, extension in white laminate and Dekton, extension in laminate similar colour to legs or Dekton).

Structure: Aluminium profile with sliding guide for extension.

Legs: Goal type in 6x3cm steel tube. The extendable leg incorporates wheels for easy opening.



es medidas

FIJA

ONE

DUO

fr mesures

en measures

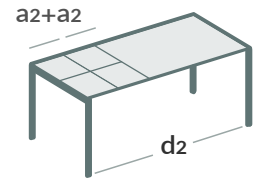
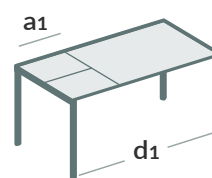
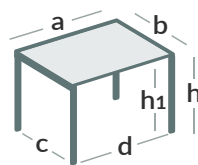

opción a tu medida

a x b	a1	a2+a2	c	d	d1	d2	h1	h	box
80x80		—	67	67	117	—			
90x90	+50	—	77	77	127	—			
110x70			57	97	157	173			
120x70			57	107	167	183	67	75	2
120x80	+60	38+38	67	107	167	183			
130x80			67	117	177	193			
130x90			77	117	177	193			
150x90			77	137	197	213			

acero h75

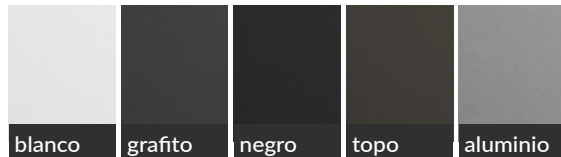

es **ENCIMERA** fr **PLATEAUX** en **WORKTOP**



encimera Laminado 19mm.
canto pvc recto igual a los laminados.
extensión Igual.

laminado | laminado matt

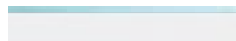

encimera Cristal 4mm + laminado 15mm.
canto pvc recto blanco.
extensión Laminado blanco.

crystal extrablanco brillo ♦ | mate ♣

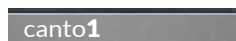

encimera Compacto 4mm + laminado 15mm.
canto1 pvc recto color igual a patas acero.
canto2 pvc recto marino (indicar en pedido).
extensión Igual.

compacto

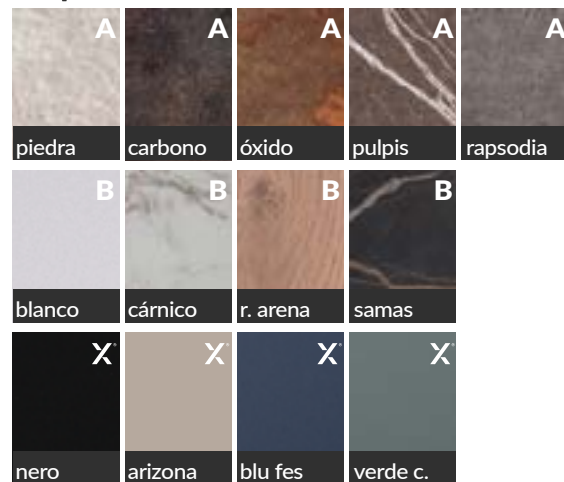

encimera DEKTON 12mm
extensión laminado color similar a DEKTON o patas de acero.



Todos los acabados y grupos. consulte p.16-17

class



FIJA

a x b	80x80	90x90	110x70	120x70	120x80	130x80	130x90	150x90
LAMINADO	506	537	494	506	518	552	591	637
LAMINADO MATT	540	583	528	540	552	598	637	683
CRISTAL BRILLO ◀	560	602	543	560	577	617	665	729
CRISTAL MATE ▶	637	697	615	637	669	712	762	857
COMPACTO A+LAMINADO	575	617	558	575	592	632	680	745
COMPACTO B+LAMINADO	602	655	585	602	618	671	718	783
FENIX +LAMINADO	663	755	646	663	695	766	818	883
GRUPO 0	886	955	862	886	909	971	1098	1175
GRUPO 1	928	995	891	928	960	1011	1152	1237
 GRUPO 2	960	1031	918	960	992	1046	1191	1283
GRUPO 3	986	1069	948	986	1026	1085	1234	1337
GRUPO 4	1032	1125	986	1032	1077	1140	1298	1414

opción a tu medida
| | | | | | | |

FIJA longitud **a** 70 hasta 180 / anchura **b** 70 – 80 – 90
Consultar precio (excepto cristal).



NEW collection



ONE

a x b	80x80	90x90	110x70	120x70	120x80	130x80	130x90	150x90
a1	50	50	60	60	60	60	60	60
LAMINADO	622	652	609	622	634	668	706	752
LAMINADO MATT	655	698	643	655	668	714	752	798
CRISTAL BRILLO \blacklozenge	675	717	658	675	692	732	780	845
CRISTAL MATE \blacktriangledown	752	812	731	752	785	828	877	972
COMPACTO A+LAMINADO	698	740	682	698	715	755	803	868
COMPACTO B+LAMINADO	732	786	715	732	749	802	849	914
FENIX+LAMINADO	817	909	800	817	849	920	972	1037
GRUPO 0	1017	1086	992	1017	1040	1102	1229	1306
GRUPO 1	1058	1126	1022	1058	1091	1142	1283	1368
 GRUPO 2	1091	1162	1049	1091	1123	1177	1322	1414
GRUPO 3	1117	1200	1078	1117	1157	1215	1365	1468
GRUPO 4	1163	1255	1117	1163	1208	1271	1429	1545

opción a tu medida
| | | | | | | |

ONE longitud a 80 hasta 160 / anchura b 70 – 80 – 90
Consultar precio (excepto cristal).



DUO

a x b	110x70	120x70	120x80	130x80	130x90	150x90
a2 + a2	38+38	38+38	38+38	38+38	38+38	38+38
LAMINADO	652	665	677	711	749	795
LAMINADO MATT	686	698	711	757	795	842
CRISTAL BRILLO \blacklozenge	702	718	735	775	823	888
CRISTAL MATE \blacktriangledown	774	795	828	871	920	1015
COMPACTO A+LAMINADO	725	742	758	798	846	911
COMPACTO B+LAMINADO	758	775	792	845	892	957
FENIX+LAMINADO	843	860	892	968	1015	1080
GRUPO 0	1035	1060	1083	1145	1272	1349
GRUPO 1	1065	1102	1134	1185	1326	1411
 GRUPO 2	1092	1134	1166	1220	1365	1457
GRUPO 3	1122	1160	1200	1258	1408	1511
GRUPO 4	1160	1206	1251	1314	1472	1588

open

es características técnicas

Mesa fija o extensible.

Encimera: Laminados, cristal, compactos A/B y Fenix, Dekton.

Extensión: Igual que la encimera (excepto en cristal, extensión en laminado blanco; y Dekton, extensión en laminado color similar a patas o Dekton).

Estructura: Perfil de aluminio con guía corredera para su extensión.

Patas: Tipo portería en tubo de acero de 6x6cm y como opción en madera fresno. La pata extensible incorpora ruedas para facilitar la apertura.

fr caractéristiques techniques

Table fixe ou extensible.

Plateau: Stratifiés, verre, compacts A/B et Fenix, Dekton.

Extension: Identique au plateau (sauf en verre, extension en stratifié blanc et Dekton, extension en stratifié de couleur similaire aux pieds ou Dekton).

Structure: Profilé d'aluminium avec glissière d'extension.

Pieds: De type cadre en tube d'acier de 6 x 6 cm, optionnellement en bois de frêne. Le pied extensible intègre des roues pour faciliter l'ouverture.

en Technical specifications

Fixed or extendable table.

Worktop: Laminates, glass, A/B compact and Fenix, Dekton.

Extension: Same as the worktop (except in glass, extension in white laminate and Dekton, extension in laminate similar colour to legs or Dekton).

Structure: Aluminium profile with sliding guide for extension.

Legs: Goal type in 6x6 cm steel tube and optionally in ash wood. The extendable leg incorporates wheels for easy opening.



es medidas

FIJA

ONE

DUO

fr mesures

en measures

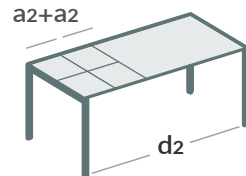
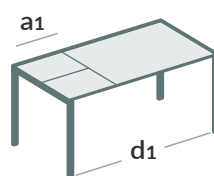
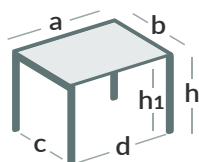

opción a tu medida



a x b	a1	a2+a2	c	d	d1	d2	h1	h	box
80x80		—	67	67	117	—			
90x90	+50	—	77	77	127	—			
110x70			57	97	157	173			
120x70			57	107	167	183	67	75	2
120x80	+60	38+38	67	107	167	183			
130x80			67	117	177	193			
130x90			77	117	177	193			
150x90			77	137	197	213			

acero h75

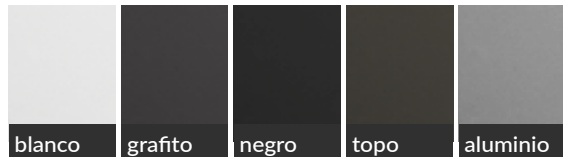

opción madera fresno h75

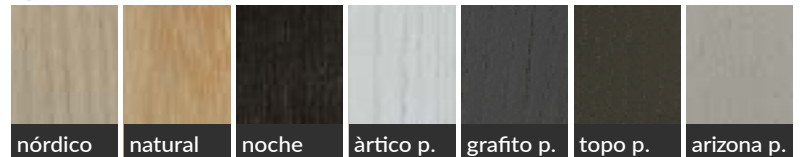

es **ENCIMERA** fr **PLATEAUX** en **WORKTOP**



encimera Laminado 19mm.
canto pvc recto igual a los laminados.
extensión Igual.

laminado | laminado matt



encimera Cristal 4mm + laminado 15mm.
canto pvc recto blanco.
extensión Laminado blanco.

cristal extrablanco brillo ♦ | mate ♣

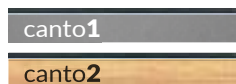

PATAS DE ACERO

encimera Compacto 4mm + laminado 15mm.
canto1 pvc recto color igual a patas acero.
canto2 pvc recto marino (indicar en pedido).
extensión Igual.

compacto



PATAS MADERA FRESNO

encimera Compacto 4mm + laminado 15mm.
canto Chapa fresno color igual a patas madera fresno.
extensión Igual.



encimera DEKTON 12mm
extensión laminado color similar a DEKTON, patas de acero o madera fresno.



Todos los acabados y grupos. consulte p.16-17

open



FIJA

a x b	80x80	90x90	110x70	120x70	120x80	130x80	130x90	150x90
LAMINADO	528	558	515	528	540	574	612	658
LAMINADO MATT	562	605	549	562	574	620	658	705
CRISTAL BRILLO ↗	582	623	565	582	598	638	686	751
CRISTAL MATE ▼	658	718	637	658	691	734	783	878
COMPACTO A+LAMINADO	597	638	580	597	614	654	702	766
COMPACTO B+LAMINADO	623	677	606	623	640	692	740	805
FENIX+ LAMINADO	685	777	668	685	717	788	840	905
GRUPO 0	908	977	883	908	931	992	1120	1197
GRUPO 1	949	1017	912	949	982	1032	1174	1258
 GRUPO 2	982	1052	940	982	1014	1068	1212	1305
GRUPO 3	1008	1091	969	1008	1048	1106	1255	1358
GRUPO 4	1054	1146	1008	1054	1098	1162	1320	1435

opción a tu medida
| | | | | | | |

FIJA longitud **a** 70 hasta 180 / anchura **b** 70 – 80 – 90
Consultar precio (excepto cristal).



es **opción** mesa Open fr **option** table Open en **option** table Open

+54

Patas madera fresno h75.



ONE

a x b	80x80	90x90	110x70	120x70	120x80	130x80	130x90	150x90
a1	50	50	60	60	60	60	60	60
LAMINADO	643	674	631	643	655	689	728	774
LAMINADO MATT	677	720	665	677	689	735	774	820
CRISTAL BRILLO ↗	697	738	680	697	714	754	802	866
CRISTAL MATE ▼	774	834	752	774	806	849	898	994
COMPACTO A+LAMINADO	720	762	703	720	737	777	825	889
COMPACTO B+LAMINADO	754	808	737	754	771	823	871	935
FENIX+LAMINADO	838	931	822	838	871	942	994	1058
GRUPO 0	1038	1108	1014	1038	1062	1123	1251	1328
GRUPO 1	1080	1148	1043	1080	1112	1163	1305	1389
GRUPO 2	1112	1183	1071	1112	1145	1198	1343	1435
GRUPO 3	1138	1222	1100	1138	1178	1237	1386	1489
GRUPO 4	1185	1277	1138	1185	1229	1292	1451	1566

DEKTON[®]
12mm

opción a tu medida



ONE longitud a 80 hasta 160 / anchura b 70 – 80 – 90
Consultar precio (excepto cristal).



DUO

a x b	110x70	120x70	120x80	130x80	130x90	150x90
a2 + a2	38+38	38+38	38+38	38+38	38+38	38+38
LAMINADO	674	686	698	732	771	817
LAMINADO MATT	708	720	732	778	817	863
CRISTAL BRILLO ↗	723	740	757	797	845	909
CRISTAL MATE ▼	795	817	849	892	942	1037
COMPACTO A+LAMINADO	746	763	780	820	868	932
COMPACTO B+LAMINADO	780	797	814	866	914	978
FENIX+LAMINADO	865	882	914	989	1037	1102
GRUPO 0	1057	1082	1105	1166	1294	1371
GRUPO 1	1086	1123	1155	1206	1348	1432
GRUPO 2	1114	1155	1188	1242	1386	1478
GRUPO 3	1143	1182	1222	1280	1429	1532
GRUPO 4	1182	1228	1272	1335	1494	1609

DEKTON[®]
12mm

poket

es características técnicas

Mesa fija o extensible.

Encimera: Laminados, cristal, compactos A/B y Fenix, Dekton.

Extensión: Igual que la encimera (excepto en cristal, extensión en laminado blanco; y Dekton, extensión en laminado color similar a patas o Dekton).

Estructura: Perfil de aluminio con guía corredera para su extensión.

Patas: Tipo portería en tubo de acero de 6x4cm y como opción en madera fresno. La pata extensible incorpora ruedas para facilitar la apertura. Disponible en h75 y h90.

fr caractéristiques techniques

Table fixe ou extensible.

Plateau: Stratifiés, verre, compact A/B et Fenix, Dekton.

Extension: Identique au plateau (sauf en verre, extension en stratifié blanc et Dekton, extension en stratifié de couleur similaire aux pieds ou Dekton).

Structure: Profilé d'aluminium avec glissière d'extension.

Pieds: De type cadre, en tube d'acier de 6 x 4 cm, ou en option, en bois de frêne. Le pied extensible intègre des roues pour faciliter l'ouverture. Disponible en h75 et en h90.

en Technical specifications

Fixed or extendable table.

Worktop: Laminates, glass, A/B compact and Fenix, Dekton.

Extension: Same as the worktop (except in glass, extension in white laminate and Dekton, extension in laminate similar colour to legs or Dekton).

Structure: Aluminium profile with sliding guide for extension.

Legs: Goal type in 6x4 cm steel tube and optionally in ash wood. The extendable leg incorporates wheels for easy opening. Available in h75 and h90.



es medidas

FIJA

ONE

DUO

fr mesures

en measures

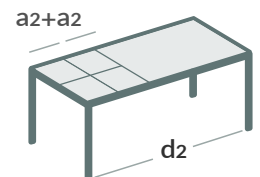
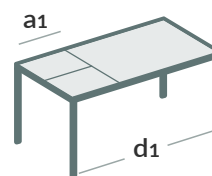
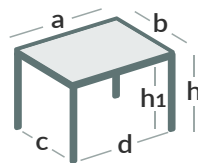

opción a tu medida

a x b	a1	a2	c	d	d1	d2	h1	h	box
100x50		—	41	87	147	—			
100x65		—	56	87	147	—			
110x65	+60	—	56	97	157	—	67	75	2
110x70		38+38	61	97	157	186	82*	90*	
120x70		38+38	61	107	167	196			
120x80		38+38	71	107	167	196			

*opción h90

acero h75 / opción h90

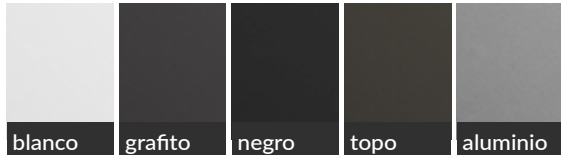

opción madera fresno h75

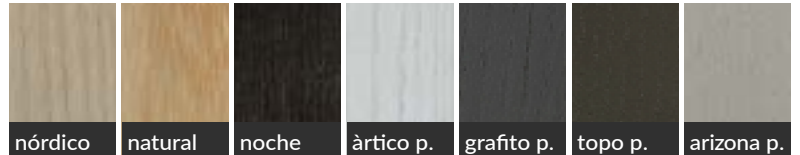

es **ENCIMERA** fr **PLATEAUX** en **WORKTOP**



encimera Laminado 19mm.
canto pvc recto igual a los laminados.
extensión Igual.

laminado | laminado matt

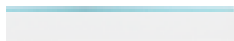

encimera Cristal 4mm + laminado 15mm.
canto pvc recto blanco.
extensión Laminado blanco.

crystal extrablanco brillo ♦ | mate ♣

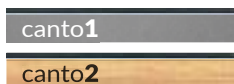

PATAS DE ACERO

encimera Compacto 4mm + laminado 15mm.
canto1 pvc recto color igual a patas acero.
canto2 pvc recto marino (indicar en pedido).
extensión Igual.

compacto

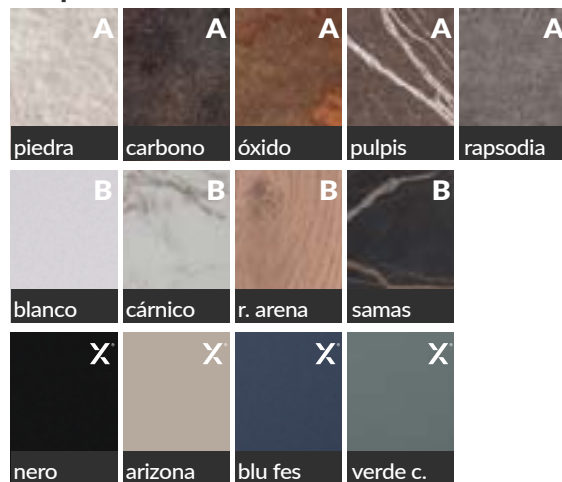

PATAS MADERA FRESNO

encimera Compacto 4mm + laminado 15mm.
canto Chapa fresno color igual a patas madera fresno.
extensión Igual.



encimera DEKTON 12mm
extensión laminado color similar a DEKTON, patas de acero o madera fresno.



Todos los acabados y grupos. consulte p.16-17



FIJA

	a x b	100x50	100x65	110x65	110x70	120x70	120x80
LAMINADO		383	406	418	426	438	451
LAMINADO MATT		417	440	452	460	472	485
CRISTAL BRILLO ↗		422	451	465	475	492	509
CRISTAL MATE ▼		469	512	534	548	569	602
COMPACTO A+LAMINADO		431	460	474	485	502	518
COMPACTO B+LAMINADO		454	483	497	511	528	545
FENIX+LAMINADO		515	545	558	572	589	622
GRUPO 0		728	751	774	794	818	842
GRUPO 1		757	782	808	823	860	892
DEKTON® 12mm GRUPO 2		778	805	832	851	892	925
GRUPO 3		809	835	862	880	918	958
GRUPO 4		845	872	898	918	965	1009

opción a tu medida
| | | | | | | |

FIJA longitud **a** 70 hasta 130 / anchura **b** 50 – 65 – 70 – 80
Consultar precio (excepto cristal).



es **opción** mesa Poket fr **option** table Poket en **option** table Poket

+38 Patas h90. Solo patas de acero.

+54 Patas madera fresno h75. Solo disponible en mesas ancho 65–70–80.



ONE

a x b	100x50	100x65	110x65	110x70	120x70	120x80
a1	60	60	60	60	60	60
LAMINADO	483	506	518	526	538	551
LAMINADO MATT	517	540	552	560	572	585
CRISTAL BRILLO ↗	522	551	565	575	592	609
CRISTAL MATE ▼	569	612	634	648	669	702
COMPACTO A+LAMINADO	538	568	582	592	609	626
COMPACTO B+LAMINADO	569	598	612	626	643	660
FENIX+LAMINADO	654	683	697	711	728	760
GRUPO 0	843	866	889	909	934	957
GRUPO 1	872	897	923	938	975	1008
 GRUPO 2	894	920	948	966	1008	1040
GRUPO 3	925	951	977	995	1034	1074
GRUPO 4	960	988	1014	1034	1080	1125

opción a tu medida
| | | | | | | |

ONE longitud **a** 90 hasta 130 / anchura **b** 50 – 65 – 70 – 80
Consultar precio (excepto cristal).



DUO

a x b	110x70	120x70	120x80
a2 + a2	38+38	38+38	38+38
LAMINADO	569	582	594
LAMINADO MATT	603	615	628
CRISTAL BRILLO ↗	618	635	652
CRISTAL MATE ▼	691	712	745
COMPACTO A+LAMINADO	635	652	669
COMPACTO B+LAMINADO	669	686	703
FENIX+LAMINADO	754	771	803
GRUPO 0	952	977	1000
GRUPO 1	982	1018	1051
 GRUPO 2	1009	1051	1083
GRUPO 3	1038	1077	1117
GRUPO 4	1077	1123	1168

poket_{mínima}

es características técnicas

Mesa extensible por el lado frontal.

Encimera: Laminados, cristal, compactos A/B y Fenix, Dekton.

Extensión: Igual que la encimera (excepto en cristal, extensión en laminado blanco; y Dekton, extensión en laminado color similar a patas o Dekton).

Estructura: Perfil de aluminio con guía corredera para su extensión.

Patas: Tipo portería en tubo de acero de 6x4cm. La pata extensible incorpora ruedas para facilitar la apertura.

fr caractéristiques techniques

Table extensible en façade

Plateau: Stratifiés, verre, compact A/B et Fenix, Dekton.

Extension: Identique au plateau (sauf en verre, extension en stratifié blanc ; et Dekton, extension en stratifié de couleur similaire aux pieds ou Dekton).

Structure: Profilé d'aluminium avec glissière d'extension.

Pieds: De type cadre, en tube d'acier de 6x4cm. Le pied extensible intègre des roues pour faciliter l'ouverture.

en Technical specifications

Extendable table on the frontside.

Worktop: Laminates, glass, A/B compact and Fenix, Dekton.

Extension: Same as the worktop (except in glass, white laminate extension; and Dekton, laminate extension in similar colour to legs or Dekton).

Structure: Aluminium profile with sliding guide for extension.

Legs: Goal type in 6x4cm steel tube. The extendable leg incorporates wheels for easy opening.



es medidas

ONE extensión frontal

fr mesures

en measures

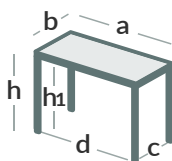

CERRADA

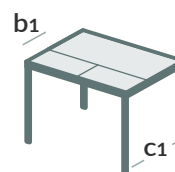

ABIERTA

a x b	b1	c	c1	d	h1	h	box
100x50		37	67		67	75	2
100x60	+30	47	77	90	67	75	2

acero h75

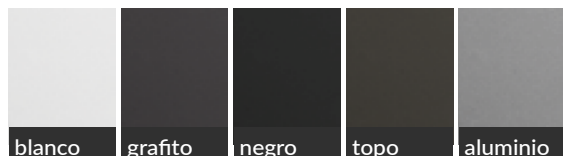

es **ENCIMERA** fr **PLATEAUX** en **WORKTOP**



encimera Laminado 19mm.
canto pvc recto igual a los laminados.
extensión Igual.

laminado | laminado matt



encimera Cristal 4mm + laminado 15mm.
canto pvc recto blanco.
extensión Laminado blanco.

crystal extrablanco brillo ♦ | mate ♣

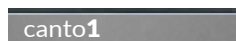

encimera Compacto 4mm + laminado 15mm.
canto1 pvc recto color igual a patas acero.
canto2 pvc recto marino (indicar en pedido).
extensión Igual.

compacto



encimera DEKTON 12mm
extensión laminado color similar a DEKTON o patas de acero.



Todos los acabados y grupos. consulte p.16-17

poket_{mínima}

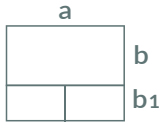

ONE

	a x b b1	100x50 30	100x60 30
LAMINADO		506	514
LAMINADO MATT		540	548
CRISTAL BRILLO \blacklozenge		551	558
CRISTAL MATE \blacktriangledown		612	628
COMPACTO A+LAMINADO		568	575
COMPACTO B+LAMINADO		598	606
FENIX +LAMINADO		683	691
GRUPO 0		843	862
GRUPO 1		872	892
 DEKTON [®] 12mm		894	915
GRUPO 2		894	915
GRUPO 3		925	946
GRUPO 4		960	983

NEW collection

classbarra

es características técnicas

Barra pared o fija.

Encimera: Laminados, compactos A/B y Fenix.

Estructura: Perfil interior de aluminio, que le aporta robustez a la barra, con la posibilidad de poner la encimera en cualquier otro material.

Patas: Tipo portería en tubo de acero de 6x3cm. La barra pared incorpora tapón con nivelador regulable 1cm para un mejor ajuste en altura.

fr caractéristiques techniques

Table haute fixe ou murale.

Plateau: Stratifiés, compactes A/B et Fenix.

Structure: Profilé interne en aluminium chargé d'augmenter la robustesse de la table haute, avec la possibilité d'installer un plateau de n'importe quel autre matériau.

Pieds: De type cadre, en tube d'acier de 6x3cm. La table haute murale intègre un bouchon avec un niveau réglable de 1 cm, pour un meilleur réglage en hauteur.

en Technical specifications

Fixed bar or wall.

Worktop: Laminates, A/B compactes and Fenix.

Structure: Aluminium inner profile, which gives robustness to the bar, with the possibility of installing any other material as worktop.

Legs: Goal type in 6x3 cm steel tube. The wall bar incorporates a stopper with a 1cm adjustable levelling device for better height adjustment.



es medidas

fr mesures

en measures

PARED 1 PATA

FIJA 2 PATAS

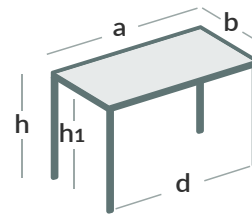
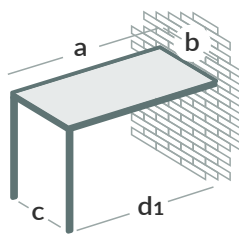

opción a tu medida



a x b	c	d	d1	h1	h	box
80X55		67	73			
100X55	48	87	93	82	90	2
120X65		107	113			
140X55		127	133			

acero h90



encimera Laminado 19mm.
Todos los laminados.
canto pvc recto igual a los laminados.

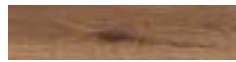

encimera Laminado 30mm.
Solo laminados Halifax.
canto pvc recto igual a los laminados.

laminado | laminado matt

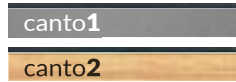

encimera Compacto 4mm + laminado 15mm.
canto1 pvc recto color igual a patas acero.
canto2 pvc recto marino (indicar en pedido).

compacto

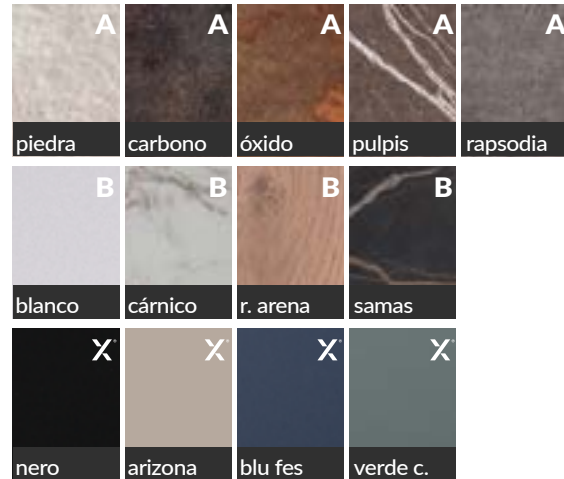

PARED 1 PATA

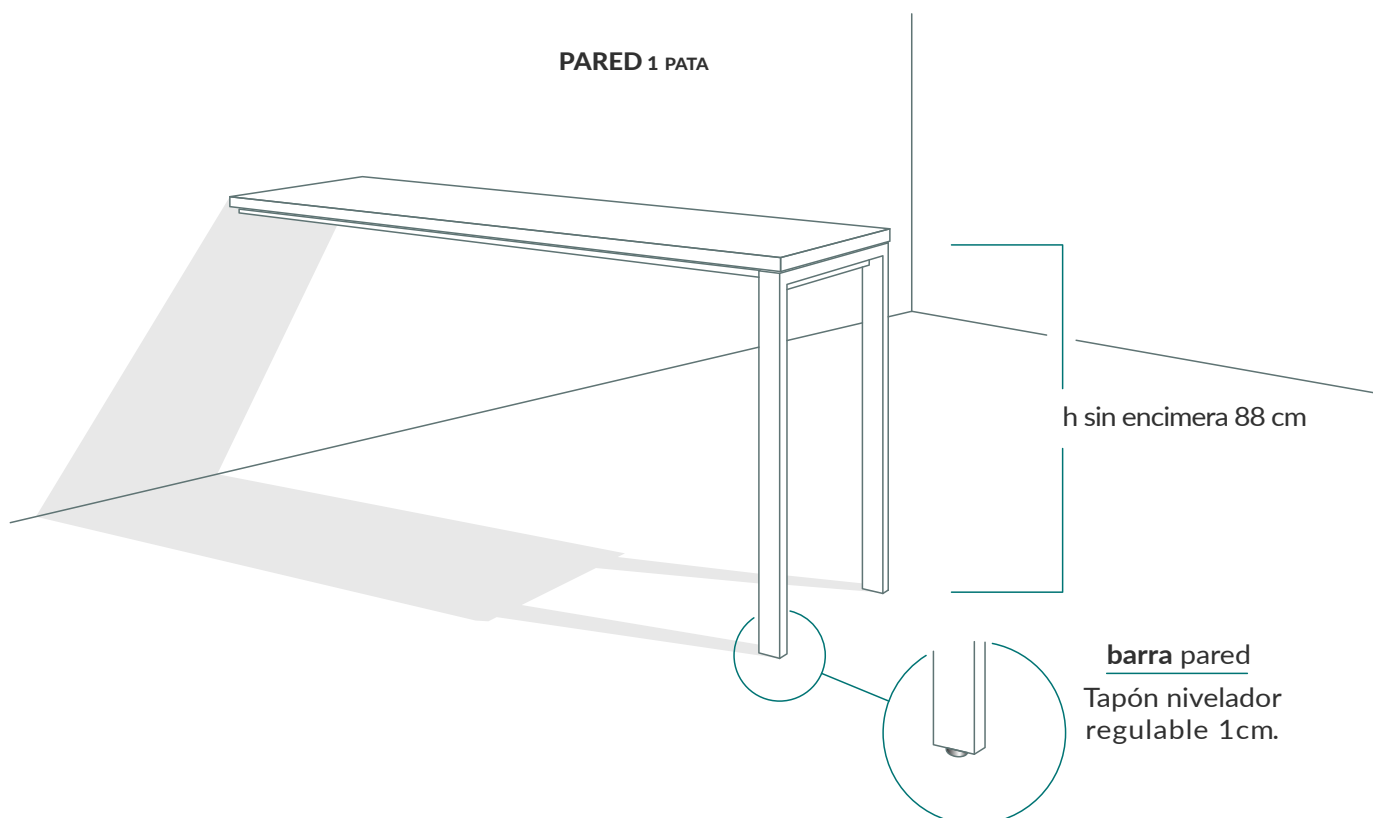

FIJA 2 PATAS

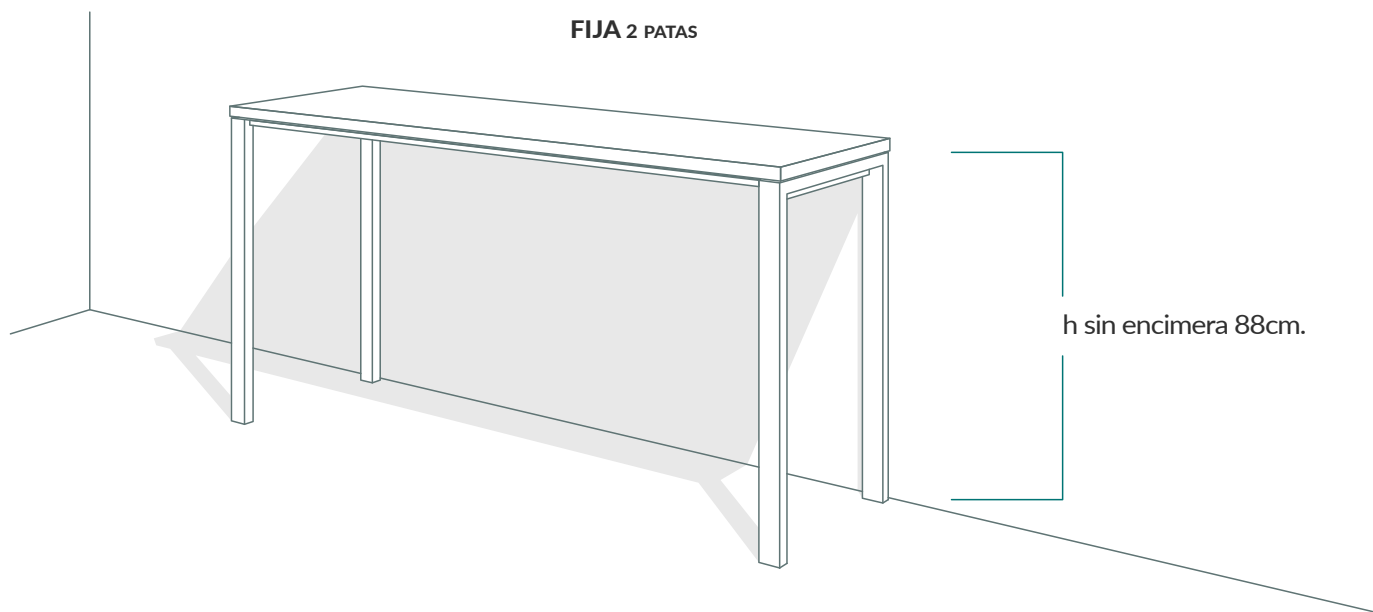



BARRA PARED 1 PATA

a x b	80x55	100x55	120x55	140x55
SIN ENCIMERA	422	440	457	483
LAMINADO	443	465	485	514
LAMINADO MATT	477	497	517	549
*LAMINADO 30mm	477	497	517	549
COMPACTO A +LAMINADO	485	506	526	546
COMPACTO B +LAMINADO	503	525	545	565
FENIX + LAMINADO	545	566	586	606

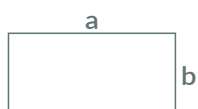

BARRA FIJA 2 PATAS

a x b	80x55	100x55	120x55	140x55
SIN ENCIMERA	483	502	518	545
LAMINADO	505	526	546	575
LAMINADO MATT	538	558	578	611
*LAMINADO 30mm	538	558	578	611
COMPACTO A +LAMINADO	546	568	588	608
COMPACTO B +LAMINADO	565	586	606	626
FENIX + LAMINADO	606	628	648	668

opción a tu medida



BARRA pared o fija longitud **a 60** hasta **200** / anchura **b 55**
Consultar precio.



lottusfija

es características técnicas

Mesa fija.

Encimera: Compactos A/B y Fenix, sobre madera contrachapada de abedul de 30mm de grosor.

Forma de encimera recta o semioval.

Patas: Chapa de acero plegada, con forma despuntada e inclinadas hacia el centro de la mesa.

fr caractéristiques techniques

Table fixe.

Plateau: Compactos A/B et Fenix, sur contreplaqué de bouleau de 30mm d'épaisseur.

Plateau à angles droits ou de forme semiovale.

Pieds: Tôle d'acier pliée, à bords émousés et inclinés vers le centre de la table.

en Technical specifications

Fixed table.

Worktop: A/B compacts and Fenix, on 30mm thick birch plywood. Straight or semi-oval worktop shape.

Legs: Folded steel sheet, with blunt shape and tilted towards the centre of the table.



FORMAS ENCIMERA



RECTA R60

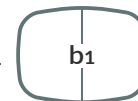

SEMIOVAL

es medidas

RECTA | SEMIOVAL

fr mesures

en measures

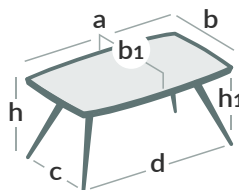

opción a tu medida



a x b	semioval b ₁	c	d	h ₁	h	box
150x85			135			
175x85	95	70	160	72,5	76	2
210x85			195			
150x90			135			
175x90	100	75	160	72,5	76	2
210x90			195			
150x100			135			
175x100	110	85	160	72,5	76	2
210x100			195			

acero h75



CONTRACHAPADO ABEDUL 30mm

encimera Compacto 4mm + Abedul 30mm.
canto biselado + barniz protector.

compacto

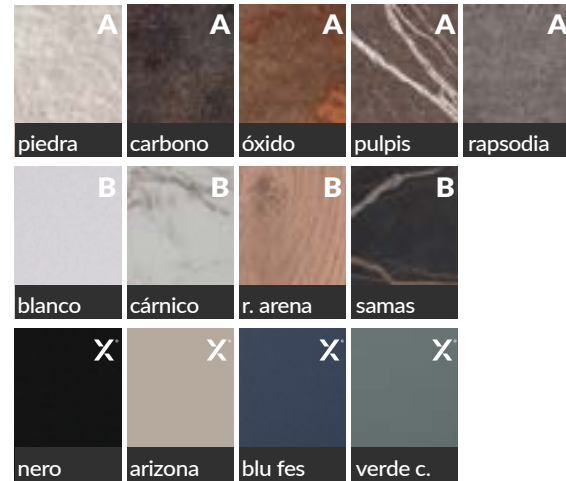



FIJA RECTA b 85

a x b	150x85	175x85	210x85
COMPACTO A+ABEDUL 30	788	946	1100
COMPACTO B+ABEDUL 30	826	992	1154
FENIX +ABEDUL 30	918	1100	1269

FIJA RECTA b 90

a x b	150x90	175x90	210x90
COMPACTO A+ABEDUL 30	788	946	1100
COMPACTO B+ABEDUL 30	826	992	1154
FENIX +ABEDUL 30	918	1100	1269

FIJA RECTA b 100

a x b	150x100	175x100	210x100
COMPACTO A+ABEDUL 30	818	977	1131
COMPACTO B+ABEDUL 30	857	1023	1185
FENIX +ABEDUL 30	949	1131	1300

opción a tu medida **FIJA RECTA** longitud **a 120** hasta **210** / anchura **b 85** hasta **100**
 | | | | | | | | Consultar precio.



NEW

collection

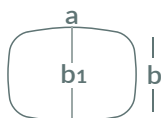

FIJA SEMIOVAL b 85

	a x b/b1	150x85/95	175x85/95	210x85/95
COMPACTO A +ABEDUL 30		788	946	1100
COMPACTO B +ABEDUL 30		826	992	1154
FENIX +ABEDUL 30		918	1100	1269

FIJA SEMIOVAL b 90

	a x b/b1	150x90/100	175x90/100	210x90/100
COMPACTO A +ABEDUL 30		818	977	1131
COMPACTO B +ABEDUL 30		857	1023	1185
FENIX +ABEDUL 30		949	1131	1300

FIJA SEMIOVAL b 100

	a x b/b1	150x100/110	175x100/110	210x100/110
COMPACTO A +ABEDUL 30		865	1023	1177
COMPACTO B +ABEDUL 30		903	1069	1231
FENIX +ABEDUL 30		995	1177	1346

opción a tu medida **FIJA SEMIOVAL** longitud **a 120** hasta **210** / anchura **b 85** hasta **100**
 | | | | | | | | | | Consultar precio.



infinity fija

es características técnicas

Mesa fija.

Encimera: Laminados, cristal, compactos A/B y Fenix, Dekton.

Estructura: Perfil de aluminio de 6x2cm, que le aporta ligereza visual y robustez, con la posibilidad de poner la encimera de cualquier otro material.

Opción de realizar estructuras para alargamiento de islas de cocina o barras a la pared, fabricadas a medida en largo, ancho y alto con 2 o 4 patas.

CONSULTE CON FABRICA.

Patatas: Perfil de aluminio de 5x5cm. Disponibles en h75, h90 y altura a medida.

fr caractéristiques techniques

Table fixe.

Plateau: Stratifiés, verre, compact A/B et Fenix, Dekton.

Structure: Profilé d'aluminium de 6 x 2 cm, qui lui donne une silhouette légère et un aspect robuste, avec la possibilité d'installer un plateau de n'importe quel autre matériau.

En option, nous réalisons sur mesure (longueur, largeur et hauteur), des structures permettant d'agrandir les îlots de cuisine ou les tables hautes murales, avec 2 ou 4 pieds. RENSEIGNEZ-VOUS AUPRÈS DE L'USINE.

Pieds: Profilé d'aluminium de 5x5cm. Disponible en h75, h90 et sur mesure en hauteur.

en Technical specifications

Fixed table.

Worktop: Laminates, glass, A/B compact and Fenix, Dekton.

Structure: 6X2cm aluminium profile, which provides visual lightness and robustness, with the possibility of installing any other material as worktop.

Optionally, structures can be produced to measure with different height, width or length, with 2 or 4 legs, to extend kitchen islands or wall bars. CONSULT WITH THE FACTORY.

Legs: 5X5cm aluminium profile. Available in h75, h90 and custom height.



es medidas

FIJACUADRADA

FIJA RECTANGULAR

fr mesures

en measures

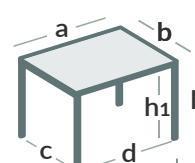
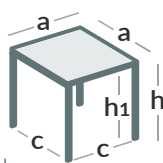

opción a tu medida

a x a	c	h1	h	box
70x70	59	67	75	1
80x80	69	82*	90*	
90x90	79			
100x100	89	67	75	
120x120	109			

*opción h90

a x b	c	d	h1	h	box
100x50	39	89			1
100x60	49	89			
110x70	59	99	67	75	
120x70	59	109	82*	90*	
120x80	69	109			
130x80	69	119			
140x90	79	129	67	75	
160x90	79	149			

*opción h90

aluminio h75 / opción h90 y altura especial



es **ENCIMERA** fr **PLATEAUX** en **WORKTOP**



encimera Laminado 19mm.
Todos los laminados.
canto pvc recto igual a los laminados.



encimera Laminado 30mm.
Solo laminados Halifax.
canto pvc recto igual a los laminados.

laminado | laminado matt

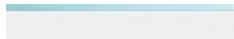

encimera Cristal 4mm + laminado 15mm.
canto pvc recto blanco.

cristal extrablanco brillo ♦ | mate ♣

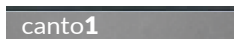

encimera Compacto 4mm + laminado 15mm.
canto1 pvc recto color igual a patas aluminio.
canto2 pvc recto marino (indicar en pedido).

compacto

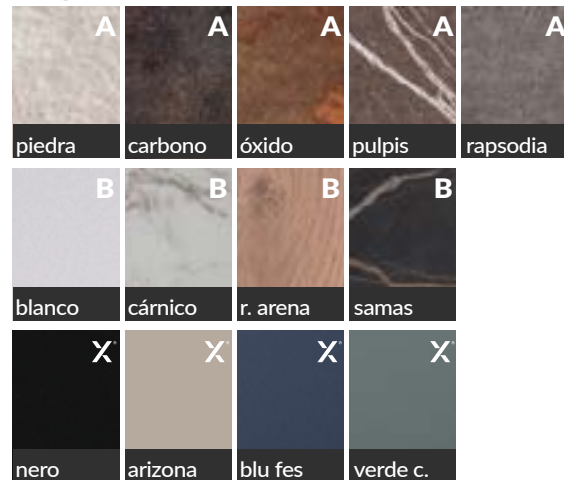

encimera DEKTON 12mm



Todos los acabados y grupos. consulte p.16-17



FIJA CUADRADA

a x a	70x70	80x80	90x90	100x100	120x120
SIN ENCIMERA	285	320	332	348	386
LAMINADO	306	349	365	388	442
LAMINADO 30mm	334	380	395	426	488
LAMINADO MATT	334	380	395	426	488
CRISTAL BRILLO	342	395	415	—	—
CRISTAL MATE	377	468	494	—	—
COMPACTO A+LAMINADO	351	405	425	451	537
COMPACTO B+LAMINADO	374	432	455	478	572
FENIX+LAMINADO	420	486	511	545	665
GRUPO 0	643	709	734	—	—
GRUPO 1	672	738	775	—	—
GRUPO 2	694	766	808	—	—
GRUPO 3	725	795	834	—	—
GRUPO 4	760	834	880	—	—

opción a tu medida
| | | | | | | |

FIJA longitud a 40 hasta 120
Medidas de 90 hasta 120 (excepto Dekton).
Consultar precio (excepto cristal).



es **opción** mesa Infinity fr **option** table Infinity en **option** table Infinity

+30

Patatas h90 y altura especial (h desde 40 a 105cm).

CUADRADA hasta 90x90cm. **RECTANGULAR** hasta 130x80cm.



FIJA RECTANGULAR

a x b	100x50	100x60	110x70	120x70	120x80	130x80	140x90	160x90
SIN ENCIMERA	285	298	320	332	342	371	398	432
LAMINADO	306	323	349	365	378	412	449	492
LAMINADO 30mm	334	351	380	395	412	458	495	538
LAMINADO MATT	334	351	380	395	412	458	495	538
CRISTAL BRILLO ↗	342	360	395	415	432	469	—	—
CRISTAL MATE ▼	377	406	468	494	525	566	—	—
COMPACTO A+LAMINADO	351	369	405	425	442	478	545	603
COMPACTO B+LAMINADO	374	392	432	452	469	514	580	645
FENIX+LAMINADO	420	442	486	511	534	606	674	735
GRUPO 0	643	669	709	734	757	817	—	—
GRUPO 1	672	698	738	775	808	857	—	—
GRUPO 2	694	726	766	808	840	892	—	—
GRUPO 3	725	755	795	834	874	931	—	—
GRUPO 4	760	794	834	880	925	986	—	—

DEKTON®
12mm

opción a tu medida
| | | | | | | |

FIJA longitud a 40 hasta 160 / anchura b 40 hasta 90
Consultar precio (excepto cristal).



tokiofija

es características técnicas

Mesa fija con pie central.

Encimera: Laminados.
Cristal y Compactos (A/B y Fenix)
sobre madera contrachapada de abedul
de 15 o 30mm de grosor, en diferentes formas.

Columna: Tubo de acero de 7x7cm.
Disponible en dos alturas.

Base: Chapa de acero de 8mm de grosor
con reguladores o fieltro.

fr caractéristiques techniques

Table fixe à pied central.

Plateau: Stratifiés.
Verre et Compacts (A/B et Fenix)
sur contreplaqué de bouleau de 15 ou 30mm
d'épaisseur, de différentes formes.

Colonne: Tube d'acier de 7x7cm. Disponible
en deux hauteurs.

Socle: Tôle d'acier de 8 mm d'épaisseur, avec
régulateurs ou feutre.

en Technical specifications

Fixed table with central base.

Worktop: Laminates.
Crystal and compacts (A/B and Fenix)
on 15 or 30 mm thick birch plywood,
in different shapes.

Column: 7x7cm steel tube.
Available in two heights.

Base: 8 mm thick steel plate
with adjusters or felt.



FORMAS ENCIMERA

RECTA



RECTA R20



SEMIOVAL



REDONDA



es medidas

fr mesures

en measures

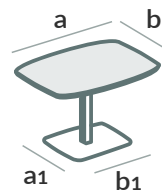
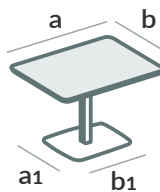
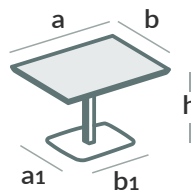

FIJA

RECTA | RECTA r20 | SEMIOVAL

h75			h90	
70x70	90x90	110x70	70x70	80x80
80x80		120x70		
		120x80		
42x42	48x48	62x42	42x42	48x48

— encimera
a x b —

— base
a1 x b1 —

REDONDA

h75		h90	
Ø70	Ø90	Ø70	Ø80
Ø80			
42x42	48x48	42x42	48x48

acero h75 y h90

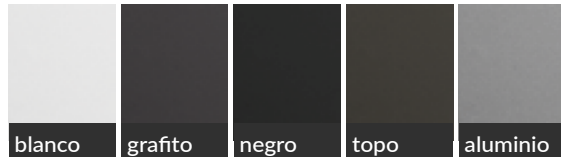

es **ENCIMERA** fr **PLATEAUX** en **WORKTOP**



encimera Laminado 19mm.
Todos los laminados.
canto pvc recto igual a los laminados.



encimera Laminado 30mm.
Solo laminados Halifax.
canto pvc recto igual a los laminados.

laminado | laminado matt



CONTRACHAPADO ABEDUL 15/30mm

encimera Cristal 4mm + Abedul 15/30mm.
canto biselado + barniz protector.

cristal extrablanco brillo | mate



CONTRACHAPADO ABEDUL 15/30mm

encimera Compacto 4mm + Abedul 15/30mm.
canto biselado + barniz protector.

compacto

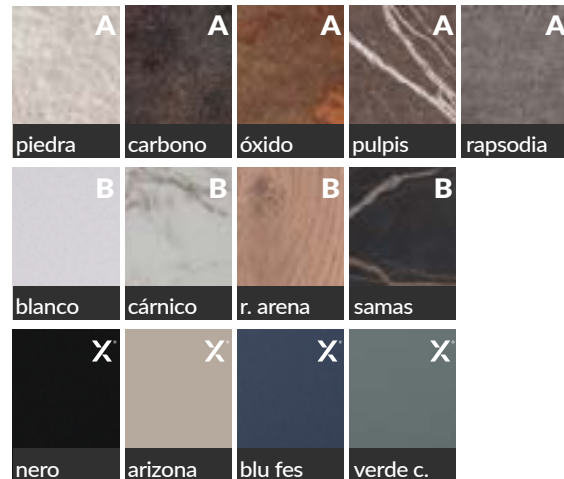



RECTA

a x b	h75						h90		
	70x70	80x80	90x90	110x70	120x70	120x80	70x70	80x80	
LAMINADO	323	331	345	369	369	388	331	346	
LAMINADO 30mm	346	354	368	392	392	411	354	369	
LAMINADO MATT	346	354	368	392	392	411	354	369	
CRISTAL BRILLO ♦♦+ ABEDUL	15mm	428	435	477	474	474	492	435	451
	30mm	466	475	537	514	514	532	474	491
CRISTAL MATE ▼♦+ ABEDUL	15mm	482	497	554	551	551	585	489	512
	30mm	520	537	614	575	575	625	528	552



RECTA r20

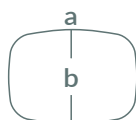

SEMIOVAL

a x b	h75						h90		
	70x70	80x80	90x90	110x70	120x70	120x80	70x70	80x80	
COMPACTO A+ABEDUL	15mm	428	435	477	474	474	492	435	451
	30mm	468	475	537	514	514	532	475	491
COMPACTO B+ABEDUL	15mm	451	458	500	497	497	515	458	474
	30mm	491	498	560	537	537	555	498	514
FENIX+ABEDUL	15mm	489	512	554	535	535	569	497	528
	30mm	529	552	614	575	575	609	537	568

NEW collection



REDONDA

	Ø	h75			h90	
		Ø70	Ø80	Ø90	Ø70	Ø80
CRISTAL BRILLO ♦ + ABEDUL	15mm	443	451	492	451	466
	30mm	482	491	552	489	506
CRISTAL MATE ♣ + ABEDUL	15mm	497	512	569	505	528
	30mm	535	552	629	543	568
COMPACTO A + ABEDUL	15mm	428	435	477	435	451
	30mm	468	475	537	475	491
COMPACTO B + ABEDUL	15mm	451	458	500	458	474
	30mm	491	498	560	498	514
FENIX + ABEDUL	15mm	489	512	554	497	528
	30mm	529	552	614	537	568

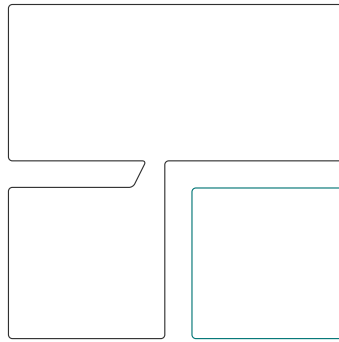

formihogar

cookin heritage

M E S A S F I J A S + E X T E N S I B L E S

T A B L E S F I X E S + E X T E N S I B L E S

F I X E D T A B L E S + E X T E N S I B L E S

fusión

cookin heritage

es características técnicas

Mesa extensible.

Encimera: Cristal brillo extrablanco de 8mm de grosor. Esquinas redondeadas r15mm.

Extensiones: Laminado blanco 12mm grosor. Bordes biselados y esquinas redondeadas r15mm.

Estructura y frente de cajón: Laminado, frente de cajón lacado con tirador integrado.

Patas: Perfil asimétrico de aluminio anodizado o lacado de 5x5cm, con esquinas redondeadas r15mm.

fr caractéristiques techniques

Table extensible.

Plateau: Verre brillant de 8 mm d'épaisseur. Angles arrondis r15mm.

Extensions: Stratifié blanc de 12mm d'épaisseur. Bords biseautés et Angles arrondis r15mm.

Structure et façade de tiroir: Stratifié, façade de tiroir laquée avec poignée intégrée.

Pieds: Profil asymétrique en aluminium anodisé ou laqué de 5 x 5 cm, avec angles arrondis r15mm.

en Technical specifications

Extendable table.

Worktop: Extra-white glossy 8 mm thick glass. Rounded corners r15 mm.

Extensions: White laminate 12mm thick. Bevelled edges and rounded corners r15mm.

Structure and drawer front: Laminate, lacquered drawer front with integrated handle.

Legs: Asymmetrical anodised or lacquered aluminium profile 5x5cm, with rounded corners r15mm.



es medidas

fr mesures

en measures

EXTENSIBLE

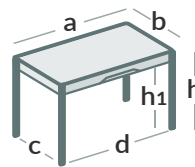

CERRADA

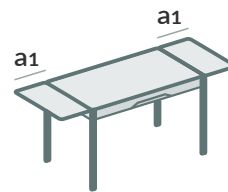

ABIERTA

a x b	a1+a1	c	d	h1	h	box
100x60	30+30	49	89	63	75	1
110x70		59	99			

es **PATAS** fr **PIEDS** en **LEGS**

aluminio h75

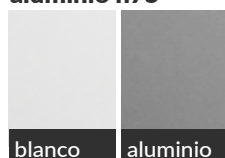

es **ESTRUCTURA+CAJÓN** fr **ESTRUCTURA+CAJÓN** en **ESTRUCTURA+CAJÓN**

laminado



es **ENCIMERA** fr **PLATEAUX** en **WORKTOP**



encimera Cristal espesor 8mm.
Esquinas r15mm.
extensión Laminado espesor 12mm.
Canto biselado.
Esquinas r15mm.

cristal extrablanco brillo



EXTENSIBLE

	a x b	100x60	110x70
	a1 + a1	30+30	30+30
CRISTAL 8mm		468	480

es **opción mesa Fusión** fr **option table Fusión** en **option table Fusión**

+15 Cubertero interior cajón. Plástico ABS gris.

es características técnicas

Mesa fija o extensible.

Encimera: Laminados y cristal (brillo/mate).

Extensiones: Igual a los laminados.

Para encimeras de cristal brillo/mate:
Laminado y canto de color igual a la estructura.

Estructura y frente de cajón: Laminado,
frente de cajón con perfil tirador integrado.

Patas: Tubo de acero de 5x5cm, con opción
en madera de fresno de 5x5cm despuntadas.

fr Caractéristiques techniques

Table fixe ou extensible.

Plateau: Stratifié et verre (brillant/mate).

Extensions: Identiques aux stratifiés.

Pour les plateaux en verre brillant/mat:
Stratifié et bord de la même couleur
que la structure.

Structure et façade de tiroir: Stratifié,
façade de tiroir avec poignée profilée intégrée.

Pieds: Tube d'acier 5x5cm, ou en option,
en bois de frêne arrondi de 5x5cm.

en Technical specifications

Fixed or extendable table.

Worktop: Laminates and glass (glossy/matte).

Extensions: Same as laminates.

For glossy/matte glass worktops: Laminate
and edge in the same colour as the structure.

Structure and drawer front: Laminate,
drawer front with integrated handle profile.

Legs: 5x5cm steel tube, optionally
in blunted 5x5cm ash wood.



es medidas

fr mesures

en measures

FIJA

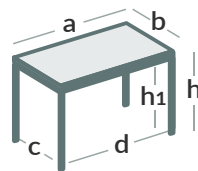

EXTENSIBLE

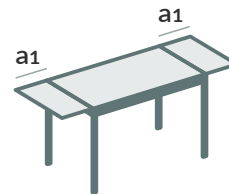

a x b	a1+a1	c	d	h1	h	box
100x50		39	89			
100x60		49	89			
100x65		54	89			
110x65	30+30	54	99	63	75	1
110x70		59	99			
120x70		59	109			
120x80		69	109			

es **PATAS** fr **PIEDS** en **LEGS**

acero h75

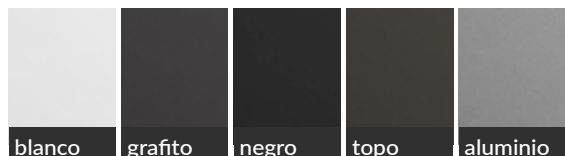

opción madera fresno h75

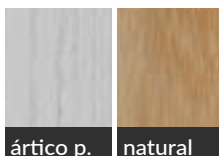

es **ESTRUCTURA+CAJÓN** fr **ESTRUCTURA+CAJÓN** en **ESTRUCTURA+CAJÓN**

laminado

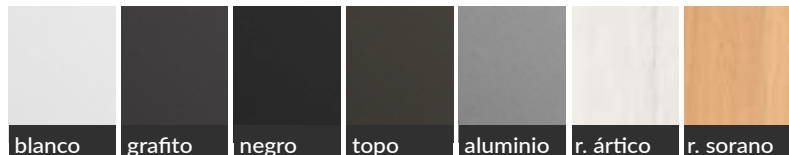

es **ENCIMERA** fr **PLATEAUX** en **WORKTOP**



encimera Laminado 19mm.
canto pvc recto igual a los laminados.
extensión Igual.

laminado | laminado matt



encimera Cristal brillo o mate.
canto 4mm + laminado 15mm.
extensión pvc recto color igual a patas.
 Laminado 19mm
 y canto color igual a patas.

cristal brillo

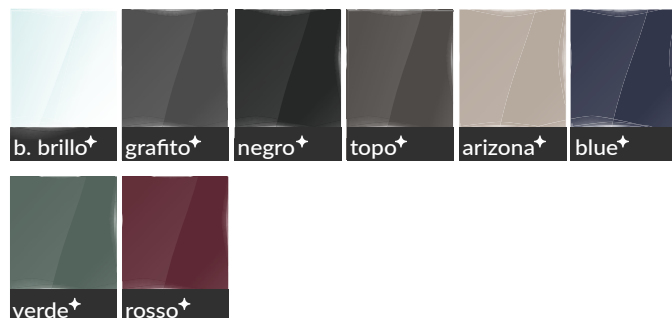

cristal mate antirrayas

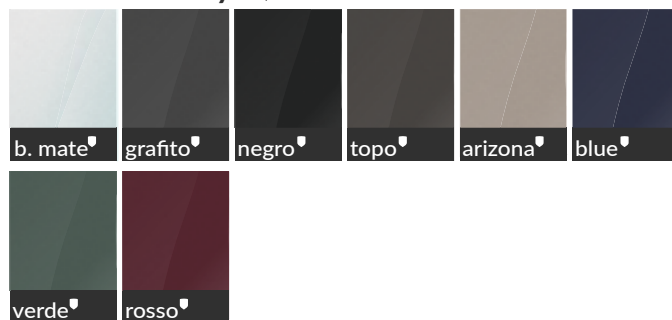



FIJA _____

a x b 100x50 100x60 100x65 110x65 110x70 120x70 120x80

LAMINADO	300	315	328	351
LAMINADO MATT	332	348	360	383
CRISTAL BRILLO↔	352	365	374	423
CRISTAL MATE▼	408	423	446	512

_____ es **opción** mesa Menta fr **option** table Menta en **option** table Menta _____

+15 Cúbertero interior cajón. Plástico ABS gris.

+40 Patas madera fresno h75.



EXTENSIBLE _____

a x b	100x50	100x60	100x65	110x65	110x70	120x70	120x80
a1+a1	30+30		30+30		30+30		30+30
LAMINADO	385	400		412		435	
LAMINADO MATT	417	432		445		468	
CRISTAL BRILLO ↗	437	449		458		508	
CRISTAL MATE ▼	492	508		531		597	

es características técnicas

Mesa extensible.

Encimera: Laminados.

Extensiones: Igual que la encimera.

Estructura: Perfil de aluminio de 6x2cm, que le aporta ligereza visual y resistencia.

Patas: Perfil de aluminio de 5x5cm. Disponibles en h75 y h90.

fr caractéristiques techniques

Table extensible.

Plateau: Stratifiés.

Extensions: Identique au plateau.

Structure: Profilé d'aluminium 6x2cm, qui lui confère un aspect léger et résistant.

Pieds: Profilé d'aluminium de 5x5cm. Disponibles en h75 et en h90.

en Technical specifications

Extendable table.

Worktop: Laminates.

Extensions: Same as the worktop.

Structure: 6x2cm aluminium, which provides visual lightness and resistance.

Legs: 5X5cm aluminium profile. Available in h75 and h90.



es medidas

fr mesures

en measures

CERRADA

ABIERTA

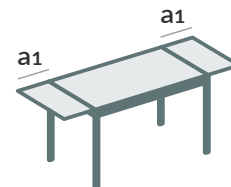
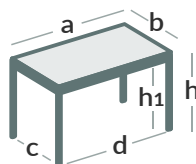

opción a tu medida



a x b	a1+a1	c	d	h1	h	box
100x50		39	89			
100x60		49	89			
100x65		54	89			
110x65	30+30	54	99	63	75	1
110x70		59	99	*78	*90	
120x70		59	109			
120x80		69	109			

*Opción h90.

aluminio h75 / opción h90

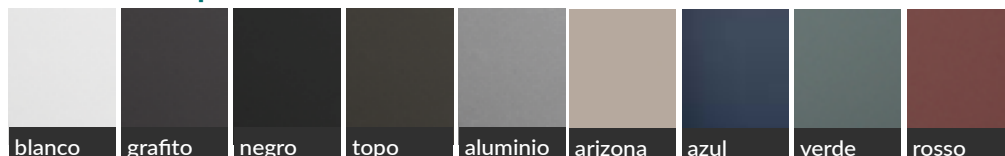

es **ENCIMERA** fr **PLATEAUX** en **WORKTOP**



encimera Laminado 19mm.
canto pvc recto igual a los laminados.
extensión Igual.

laminado | laminado matt

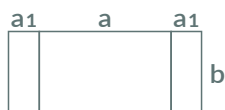

EXTENSIBLE

a x b	100x50	100x60	100x65	110x65	110x70	120x70	120x80
a1+a1	30+30	30+30		30+30		30+30	
LAMINADO	405	420		442		471	
LAMINADO MATT	438	454		475		505	

opción a tu medida **EXTENSIBLE** longitud **a 90** hasta **140** / anchura **b 50** hasta **90**
 Consultar precio.

es **opción** mesa Alutec fr **option** table Alutec en **option** table Alutec

+30 Patas h90.
 Medida mesa máximo 120x80cm.

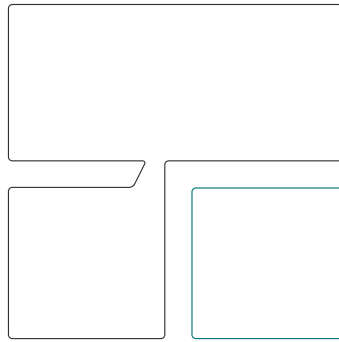

formihogar

S I L L A S + T A B U R E T E S

C H A I S E S + T A B O U R E T S

C H A I R S + S T O O L S

A C A B A D O S
S I L L A S

+

T A B U R E T E S

F I N I T I O N S
C H A I S E S

+

T A B O U R E T S

F I N I S H I N G S
C H A I R S

+

S T O O L S

acero

opción color

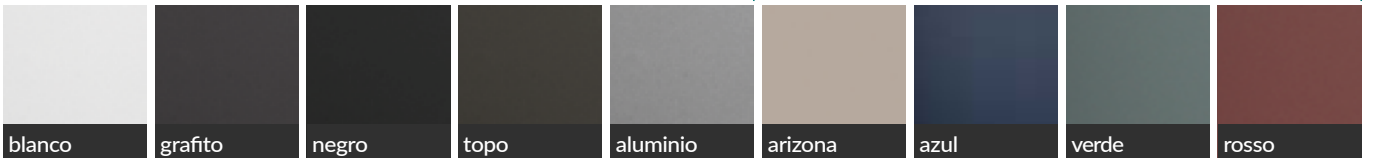

madera de fresno



es ASIENTO fr ASSIS en SEAT

madera de fresno



tapizado VALENCIA

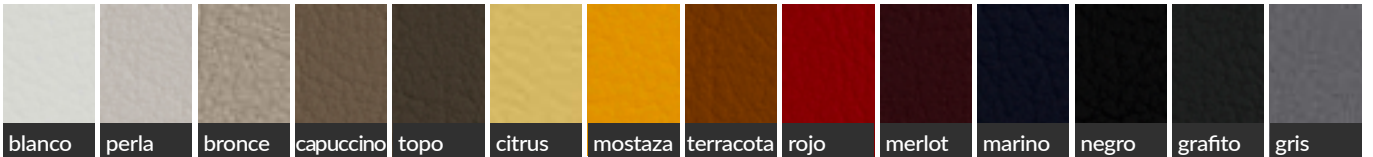

tapizado LINETEX



tapizado MYSTIC AQUACLEAN

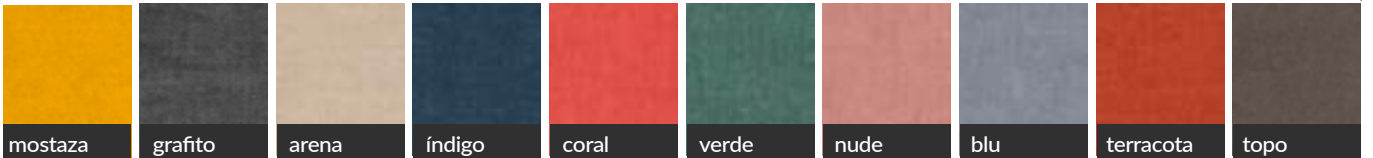

tapizado SILVERTEX



tapizado MAGLIA

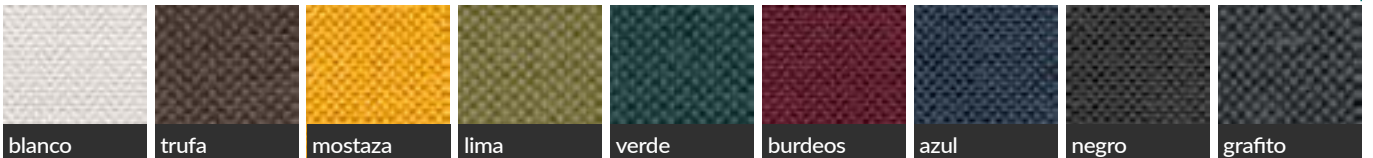

tapizado FUJI

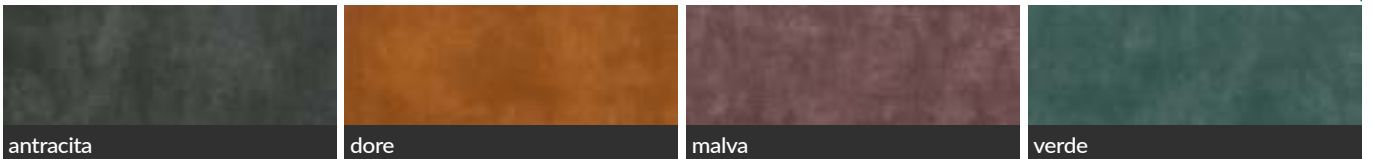

tapizado FROCA COMBINADO



*solo reverso respaldo

nature SILLA

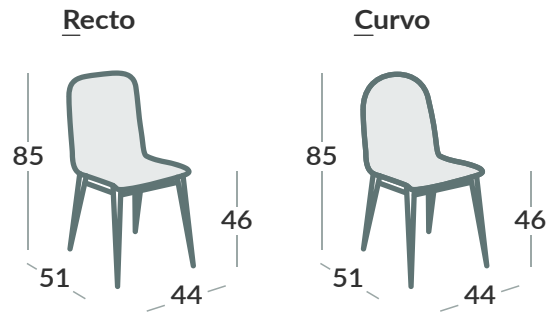

ASIENTO

ESTRUCTURA	RESPALDO	tapizado valencia linetex mystic	tapizado silvertex maglia fuji froca	combinado ANVERSO/REVERSO froca	madera fresno
madera fresno	<u>Recto</u> <u>Curvo</u>	188	197	197	—

loop SILLA

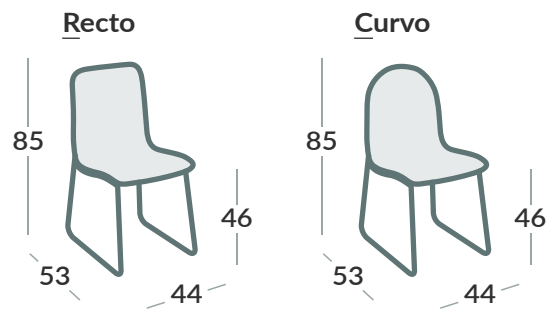

ASIENTO

ESTRUCTURA	RESPALDO	tapizado valencia linetex mystic	tapizado silvertex maglia fuji froca	combinado ANVERSO/REVERSO froca	madera fresno
acero	<u>Recto</u> <u>Curvo</u>	188	197	197	188

opción estructura

+12 acero color (Arizona, Azul, Verde o Rosso).

geniu SILLA

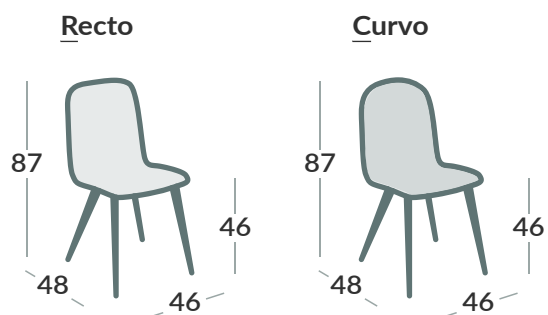

ASIENTO

ESTRUCTURA	RESPALDO	tapizado valencia linetex mystic	tapizado silvertex maglia fuji froca	combinado ANVERSO/REVERSO froca	madera fresno
madera fresno	<u>Recto</u> <u>Curvo</u>	182	191	191	182

elica SILLA

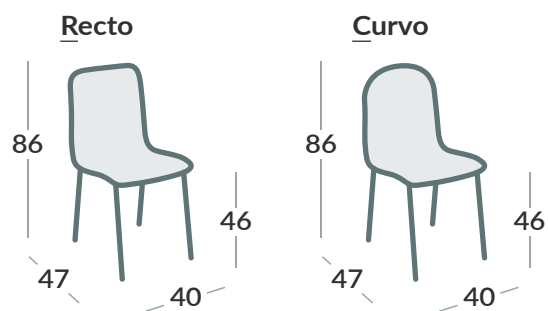

ASIENTO

ESTRUCTURA	RESPALDO	tapizado valencia linetex mystic	tapizado silvertex maglia fuji froca	combinado ANVERSO/REVERSO froca	madera fresno
acero	<u>Recto</u> <u>Curvo</u>	155	165	165	155

opción estructura

+12 acero color (Arizona, Azul, Verde o Rosso).

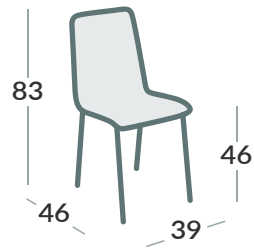

ASIENTO

ESTRUCTURA	tapizado valencia linetex mystic	tapizado silvertex maglia fuji froca	combinado ANVERSO/REVERSO froca	madera fresno
acero	149	158	158	149

opción estructura

+12 acero color (Arizona, Azul, Verde o Rosso).

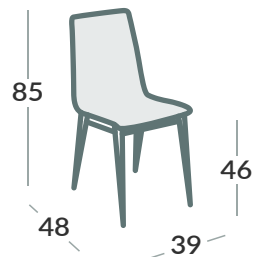

ASIENTO

ESTRUCTURA	tapizado valencia linetex mystic	tapizado silvertex maglia fuji froca	combinado ANVERSO/REVERSO froca	madera fresno
madera fresno	175	185	185	175

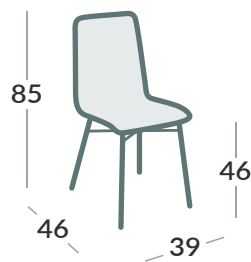

ASIENTO

ESTRUCTURA	tapizado valencia linetex mystic	tapizado silvertex maglia fuji froca	combinado ANVERSO/REVERSO froca	madera fresno
acero	155	165	165	155

opción estructura

- +12 acero color (Arizona, Azul, Verde o Rosso).



NEW collection

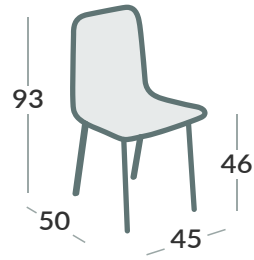

ASIENTO

ESTRUCTURA	tapizado valencia linetex mystic	tapizado silvertex maglia fuji froca	combinado ANVERSO/REVERSO froca
acero	172	182	182

opción estructura

+12 acero color (Arizona, Azul, Verde o Rosso).



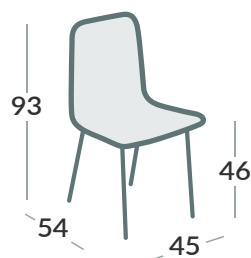

ASIENTO

ESTRUCTURA	tapizado valencia linetex mystic	tapizado silvertex maglia fuji froca	combinado ANVERSO/REVERSO froca
acero	185	194	194

opción estructura

+12 acero color (Arizona, Azul, Verde o Rosso).



cross_{SILLA}



NEW collection

ESTRUCTURA

acero

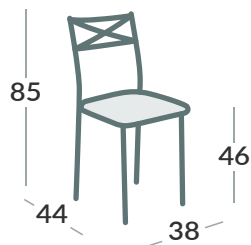

ASIENTO

tapizado
valencia
linetex

95

tapizado
silvertex
maglia

100

bimba_{SILLA}

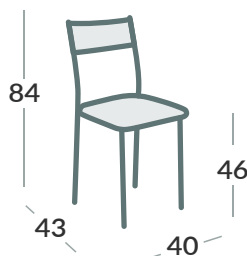

ASIENTO

ESTRUCTURA

acero

RESPALDO

acero
todos los acabados

tapizado
valencia
linetex

95

tapizado
silvertex
maglia

100

kiss_{SILLA}



NEW collection

ESTRUCTURA

acero

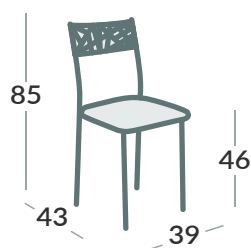

ASIENTO

tapizado
valencia
linetex

95

tapizado
silvertex
maglia

100

madera
fresno

100

opción estructura cross – bimba– kiss – coral – core– inés

+15 acero color (Arizona, Azul, Verde o Rosso).

coral^{SILLA}

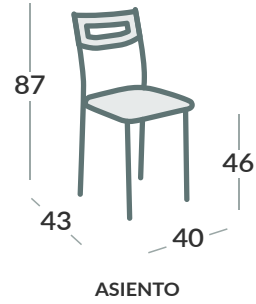

ESTRUCTURA

acero

tapizado
valencia
linetex

88

tapizado
silvertex
maglia

92

core^{SILLA}

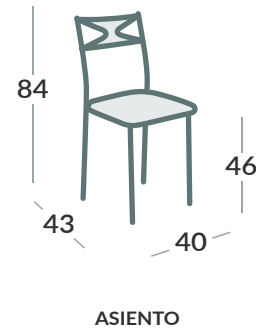

NEW collection

ESTRUCTURA

acero

tapizado
valencia
linetex

92

tapizado
silvertex
maglia

97

inés^{SILLA}

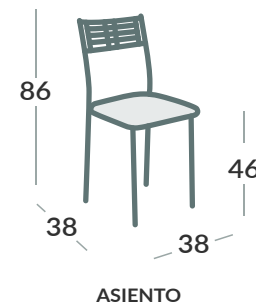

ESTRUCTURA

acero

tapizado
valencia
linetex

83

tapizado
silvertex
maglia

88

nature TABURETE



Recto h65/h80

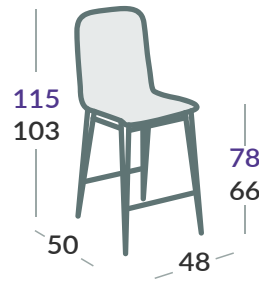

Curvo h65/h80

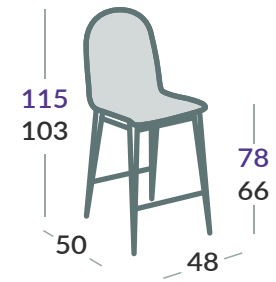

ASIENTO

ESTRUCTURA	RESPALDO	ALTURA	tapizado valencia linetex mystic	tapizado silvertex maglia fuji froca	combinado ANVERSO/REVERSO froca	madera fresno
madera fresno	<u>Recto</u> <u>Curvo</u>	h65	218	228	228	—
		h80	228	237	237	—

p.888 loop TABURETE

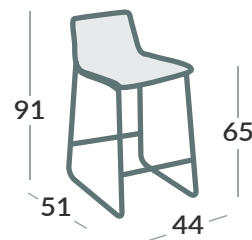

ASIENTO

ESTRUCTURA	ALTURA	tapizado valencia linetex mystic	tapizado silvertex maglia fuji froca	combinado ANVERSO/REVERSO froca	madera fresno
acero	h65	206	215	215	206

opción estructura

+12 acero color (Arizona, Azul, Verde o Rosso).

elica TABURETE



Recto h65/h80

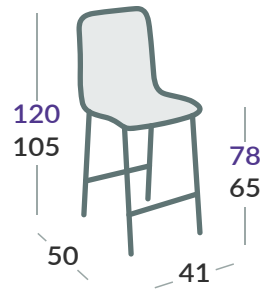

Curvo h65/h80

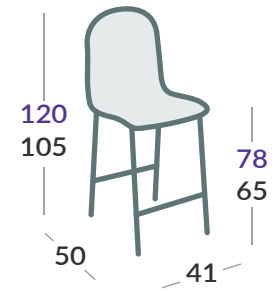

ASIENTO

ESTRUCTURA	RESPALDO	ALTURA	tapizado valencia linetex mystic	tapizado silvertex maglia fuji froca	combinado ANVERSO/REVERSO froca	madera fresno
acero	<u>Recto</u> <u>Curvo</u>	h65	182	191	191	182
		h80	189	198	198	189

— opción estructura —

+12 acero color (Arizona, Azul, Verde o Rosso).

oxford TABURETE



Alto

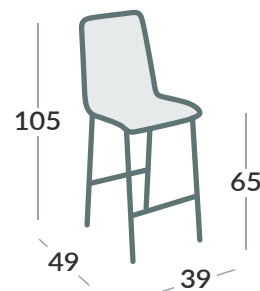

Bajo

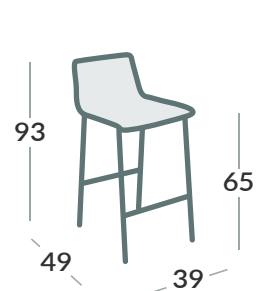

ASIENTO

ESTRUCTURA	RESPALDO	ALTURA	tapizado valencia linetex mystic	tapizado silvertex maglia fuji froca	combinado ANVERSO/REVERSO froca	madera fresno
acero	<u>Alto</u> <u>Bajo</u>	h65	175	185	185	175

— opción estructura —

+12 acero color (Arizona, Azul, Verde o Rosso).

rental TABURETE

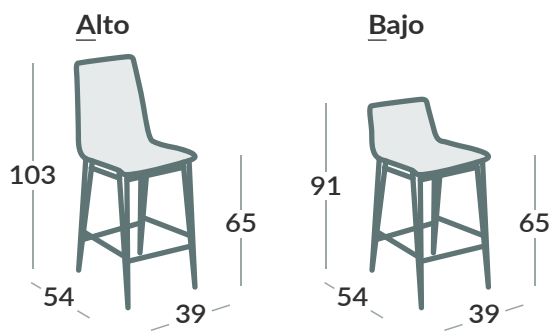

ASIENTO

ESTRUCTURA	RESPALDO	ALTURA	tapizado valencia linetex mystic	tapizado silvertex maglia fuji froca	combinado ANVERSO/REVERSO froca	madera fresno
madera fresno	<u>Alto</u> <u>Bajo</u>	h65	206	215	215	206

stilo TABURETE

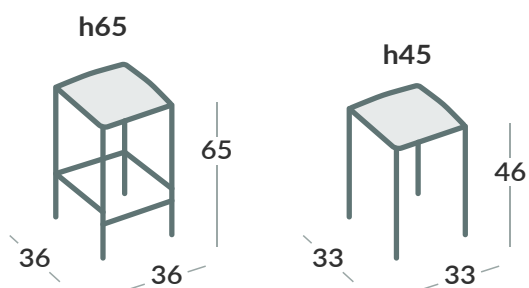

ASIENTO

ESTRUCTURA	ALTURA	tapizado valencia linetex mystic	tapizado silvertex maglia fuji froca	madera fresno
acero	h45	74	78	78
	h65	102	106	106

opción estructura

+12 acero color (Arizona, Azul, Verde o Rosso).

kiss TABURETE

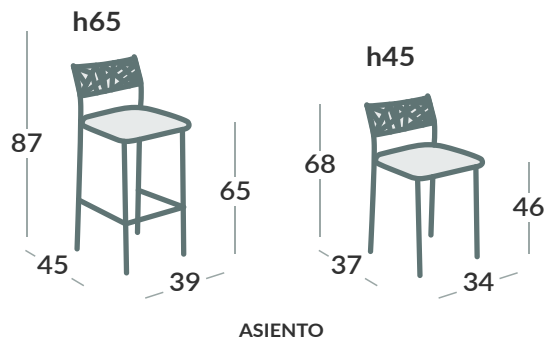

NEW collection

ESTRUCTURA	ALTURA	tapizado valencia linetex	tapizado silvertex maglia	madera fresno
acero	h45	92	97	97
	h65	120	125	125

opción estructura

+15 acero color (Arizona, Azul, Verde o Rosso).

inés TABURETE

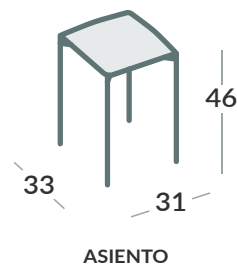

ESTRUCTURA	ALTURA	tapizado valencia linetex	tapizado silvertex maglia
acero	h45	65	69

opción estructura

+12 acero color (Arizona, Azul, Verde o Rosso).

CONDICIONES GENERALES

Este catálogo técnico anula los anteriores, quedando descatalogados todos los artículos que no figuren en el presente catálogo.

Las descripciones y fotografías contenidas en nuestro catálogo deberán entenderse únicamente a nivel informativo.

Los colores representados en la impresión fotomecánica pueden presentar variaciones con respecto a los colores y acabados originales.

*Pueden surgir diferencias en el color de los acabados de **crisales, maderas, metales y tejidos** ya que no es posible garantizar una tintada constante en el tiempo.*

*El **Dekton o cerámica** pueden llevar pequeños puntos o imperfecciones inferiores a 2 mm, no siendo por ello motivo de devolución.*

*La ***madera de fresno** y la ***madera contrachapada de abedul** al ser un material natural puede contener nudos e imperfecciones o vetas diferentes en la misma pieza.*

Nuestra política es la de mejorar continuamente los productos, por ello nos reservamos el derecho de introducir las variaciones técnicas y de diseño que estimemos oportunas o anulación de modelos o acabados sin previo aviso.

Pedidos: Para eliminar posibles errores de interpretación rogamos que el envío de sus pedidos se realice por correo electrónico a pedidos@formihogar.com

Para medidas especiales consultar con fabrica.

Precios: La tarifa se establece en PUNTOS, se han de convertir a euros aplicando el coeficiente correspondiente.

IVA NO INCLUIDO. Esta tarifa anula las anteriores, FORMIHOGAR, puede variar o modificar como estime pertinente sus precios.

Portes: Portes pagados para pedidos superiores a 300 euros B.I. Para pedidos inferiores a 300 euros B.I., se cargará en factura el importe por expedición, el coste del porte se indicará en la confirmación del pedido.

Consultar el importe según zona de envío.

Condiciones de pago: El cliente cumplirá con las condiciones de pago pactadas con FORMIHOGAR, en caso contrario FORMIHOGAR se reserva ejercer las acciones que le correspondan en derecho.

Si alguna cantidad no hubiera sido abonada en el día de vencimiento de la factura se suspenderán las entregas posteriores hasta el pago debido. Las mercancías suministradas permanecerán en propiedad de FORMIHOGAR, hasta que se haya producido su pago total según condiciones específicas en factura.

Para pedidos especiales y contract, será imprescindible el pago anticipado del 30% para la aceptación del pedido.

Jurisdicción: Serán únicamente competentes, en caso de litigio, los Tribunales de Cuéllar.

Reclamaciones / devoluciones: Para reclamaciones se adjuntará por mail fotografías y descripción detallada de la reclamación.

La devolución deberá mantener siempre el embalaje original. No se aceptará la devolución de la mercancía sin la conformidad explícita de FORMIHOGAR. Los portes por cambio de color o modelo serán a cargo del cliente y se abonará el 75% del valor original facturado.

*No se aceptará la devolución de pedidos por causas no imputables a FORMIHOGAR. En ningún caso se aceptarán devoluciones de pedidos de medidas especiales. Debido al proceso de fabricación, no se aceptarán anulaciones de pedidos transcurridos **2 días** desde su recepción.*

Transporte: Al recibir la mercancía revise el embalaje y que el número de bultos sea correcto.

*Si observa algún desperfecto en el embalaje, tenemos concertado un seguro con la agencia de transportes el cual cubre desperfectos, siempre y cuando la reclamación se efectuó en un plazo máximo de **24 horas**, para ello es imprescindible que en el albarán conste SALVO REVISIÓN. Si esto no fuera así FORMIHOGAR no se responsabilizará de dichos desperfectos.*

Las entregas de mercancía solo se efectuarán en locales comerciales o almacenes logísticos, en ningún caso en domicilios particulares.

Garantía: Los productos suministrados por FORMI-HOGAR tienen una garantía de 2 años desde la fecha de la factura.

El uso, manipulación o mantenimiento inadecuado del producto anula la garantía.

Queda excluida de la garantía la rotura de encimeras de cristal, Dekton o cerámica.

*madera contrachapada de abedul



ejemplo: compacto + abedul

**La madera contrachapada de abedul, puede contener en su borde o superficie, pequeños nudos, imperfecciones o tonos negros diferentes, debido a su composición de chapas de madera natural superpuestas.*

Dichas imperfecciones se preparan, para posteriormente aplicar barniz el cual le aporta la protección del contrachapado al paso del tiempo y uso.

*madera fresno



Las patas de mesa y estructuras de sillas o taburetes están realizadas en madera maciza de fresno y puede contener vetas y tonos irregulares, matices o nudos de la propia madera, que resaltan aún más la belleza de la madera y le confiere un aspecto único a cada pieza.

No es posible garantizar en los modelos en madera maciza de fresno, que las vetas o tonos en una misma pieza sean idénticos o regulares.

No se admite la devolución por dichas características en la madera.

+ I N F O
ATENCIÓN AL
CLIENTE

 +34 921 140 063

 info@formihogar.com

 pedidos@formihogar.com



formihogar
com